

UN0413N1R4-PD56

ROHS

N-Channel Enhancement Mode MOSFET

Product Summary

V _{DS}	45V
I _D (@TA=25°C)	139A
R _{DS(ON)} (@V _{GS} =10V I _D =20A)	≤2.4mΩ
R _{DS(ON)} (@V _{GS} =4.5V I _D =20A)	≤3.0mΩ

Features

- ◆ Proprietary Trench Gate Device Design and Processes
- ◆ Low R_{DS(ON)}
- ◆ 100% Avalanche Tested
- ◆ Reliable and Rugged
- ◆ RoHS complian

Applications

- ◆ DC/DC Converter
- ◆ Battery Management System
- ◆ Industrial and Motor Drive applications
- ◆ Synchronous rectifier applications
- ◆ Half-bridge and full-bridge topologies

Package Marking And Ordering information

Part Number	Package Type	Packaging	Reel(pcs)
UN0413N1R4-PD56	DFN5*6-8L	Tape & Reel	5,000



www.unsemi.com.tw

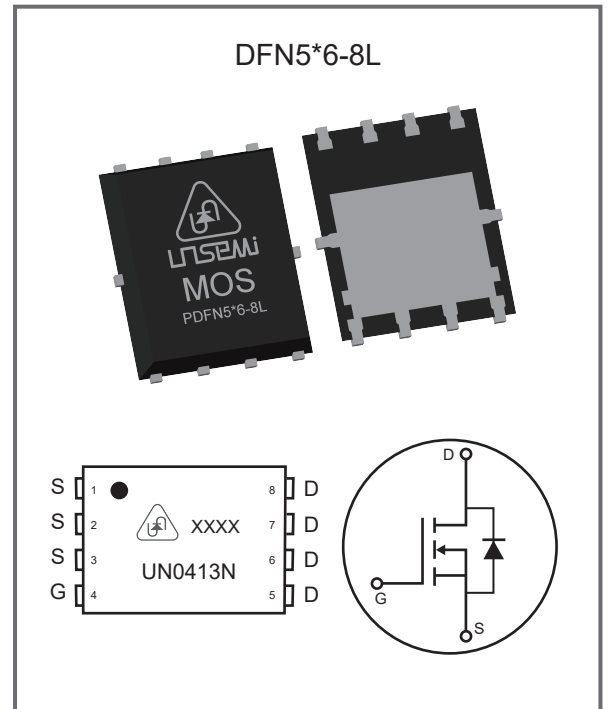

Absolute Maximum Ratings TC = 25°C unless otherwise specified

Parameter		Symbol	Maximum	Units
Drain to Source Voltage		VDs	45	V
Continuous Drain Current ¹⁾	@TC=25°C	ID	139	A
	@TC=100°C		88	
Drain Current Pulsed ²⁾		IDM	417	A
Gate-Source Voltage		VGS	±20	V
Single Pulsed Avalanche Energy ³⁾		EAS	467	mJ
Power Dissipation	@TC=25°C	PD	83	W
	@TC=100°C		33	
Junction and Storage Temperature Range		Tstg,TJ	-55~150	°C

Thermal Characteristics

Parameter	Symbol	Tay	Max	Units
Thermal Resistance from Junction to Ambient	RθJA	--	60	°C/W
Thermal Resistance, Junction to Case	RθJC	--	1.5	°C/W

Notes:

- 1) The maximum current rating is silicon wafer limited.
- 2) Single pulse width limited by junction temperature .
- 3) Limited by TJ(MAX), Starting at TJ=25°C, Rg=25Ω, L=0.5mH.
- 4) Design parameters,Guaranteed by design, not subject to production.

Electrical Characteristics at Tc = 25°C unless otherwise specified

Parameter	Symbol	Test Conditions	Min	Typ	Max	Units
STATIC PARAMETERS						
Drain-Source Breakdown Voltage	BVDSS	VGS = 0V, ID = 250uA	45			V
Drain-Source Leakage Current	IDSS	VDS = 45V, VGS = 0V			1.0	μA
Gate-source leakage current	IGSS	VGS = ±20V, VDS = 0V			±100	nA
Gate-Source Threshold Voltage	VGS(TH)	VGS = VDS, ID = 250μA	1.0	-	2.5	V
Drain-Source On-State Resistance	RDS(ON)	VGS = 10V, ID = 20A		1.4	2.4	mΩ
		VGS = 4.5V, ID = 20A		1.8	3.0	mΩ
Forward Transconductance(GMP)	GFS	VDS = 5.0V, ID = 30A		64		S
Body-Diode PARAMETERS						
Drain-Source Diode Forward Voltage	VSD	IS = 1A, VGS = 0V		0.7	1.1	V
Body Diode Reverse Recovery Time	trr	IF = 20A di/dt = 100A/μs		49		ns
Body Diode Reverse Recovery Charge	Qrr			71		nC
DYNAMIC PARAMETERS ⁴⁾						
Gate Resistance	Rg	F = 1MHZ		1.3		Ω
Input Capacitance	Ciss	VGS = 0V VDS = 20V F = 1MHZ		8358		pF
Output Capacitance	Coss			1128		pF
Reverse Transfer Capacitance	Crss			1092		pF
Gate charge Total	Qg	VGS = 10V VDS = 20V ID = 20A		110		nC
Gate to Source Charge	Qgs			31.4		nC
Gate to Drain Charge	Qgd			33.5		nC
SWITCHING PARAMETERS ⁴⁾						
Turn-On Delay Time	td(ON)	VDS = 20V, VGS = 10V Rg = 1.5Ω		21.4		ns
Turn-On Rise Time	tr			28.3		ns
Turn-Off Delay Time	td(OFF)			66.9		ns
Turn-Off Fall Time	tf			36.1		ns

Electrical Characteristics Curves

Fig. 1 Power Derating

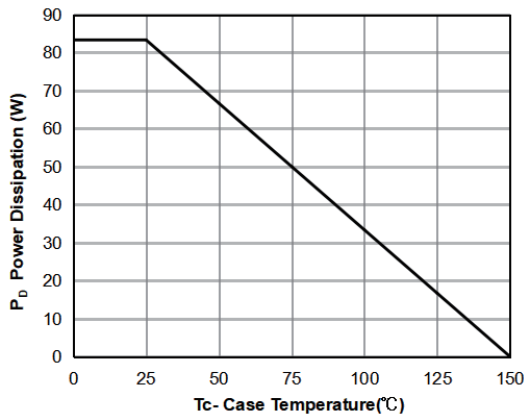

Fig. 2 Maximum Drain Current vs. Case Temperature

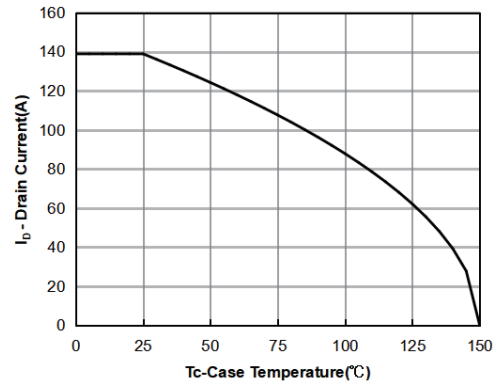

Fig. 3 Output Characteristics

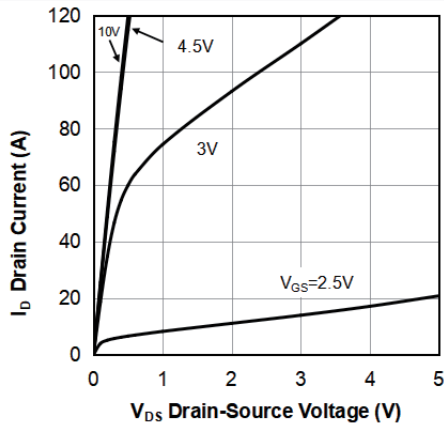

Fig. 4 Transfer Characteristics

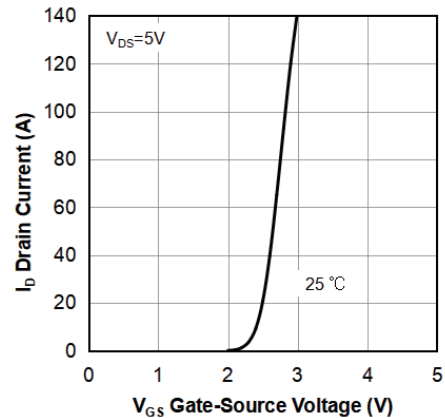

Fig. 5 On-Resistance vs. Drain Current and Gate Voltage

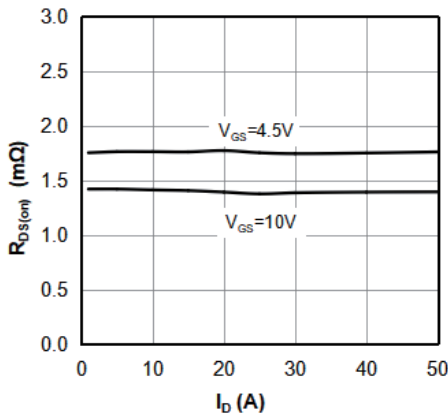
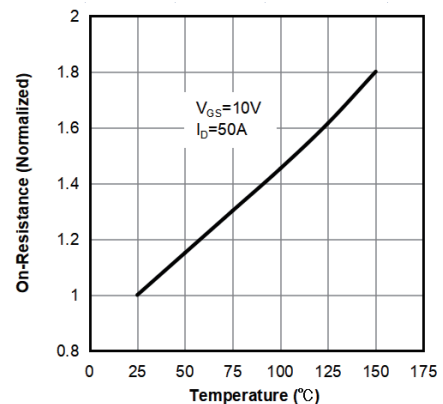

Fig. 6 On-Resistance vs. Junction Temperature/ Normalized On-Resistance



Electrical Characteristics Curves

Fig. 7 On-Resistance vs. Gate-Source Voltage

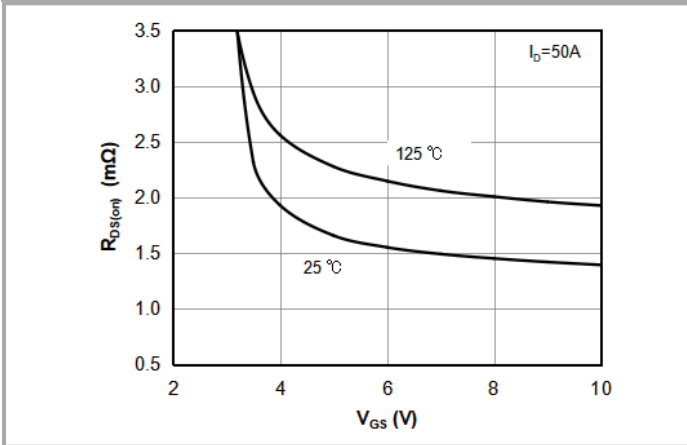

Fig. 8 Body-Diode Characteristics

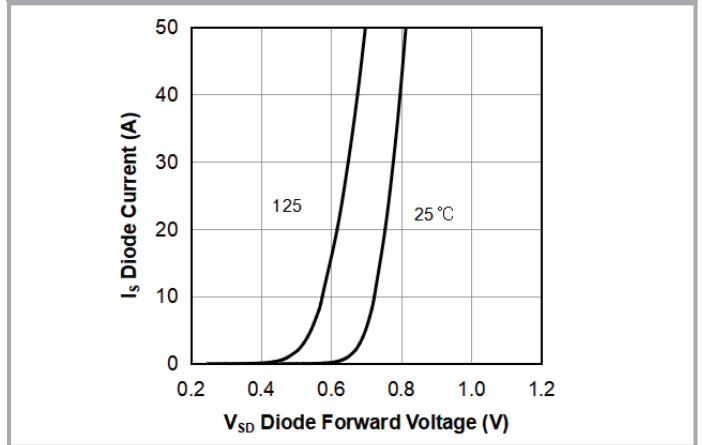

Fig. 9 Capacitance Characteristics

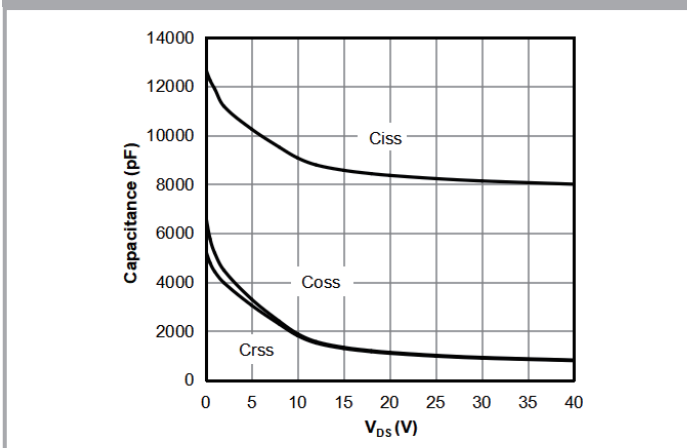

Fig. 10 Gate Charge Characteristics

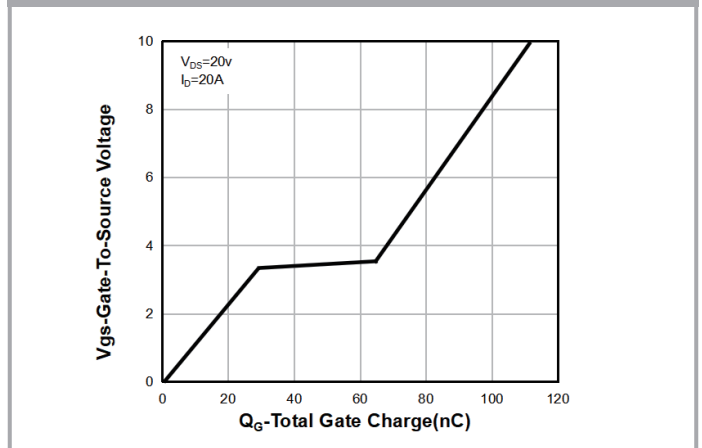
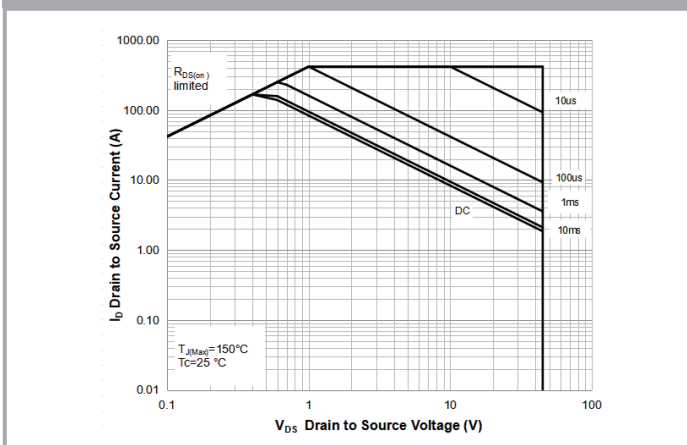
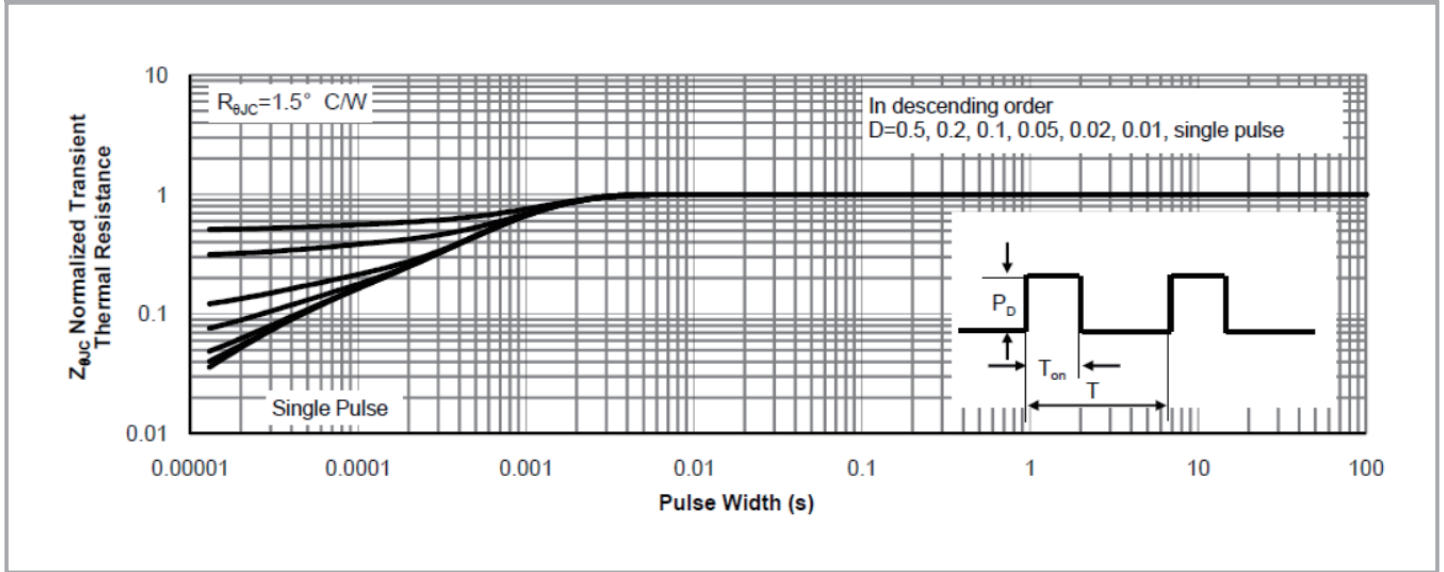

Fig. 11 Safe Operation Area



Electrical Characteristics Curves

Fig. 12 Normalized Maximum Transient thermal impedance



Test Circuit

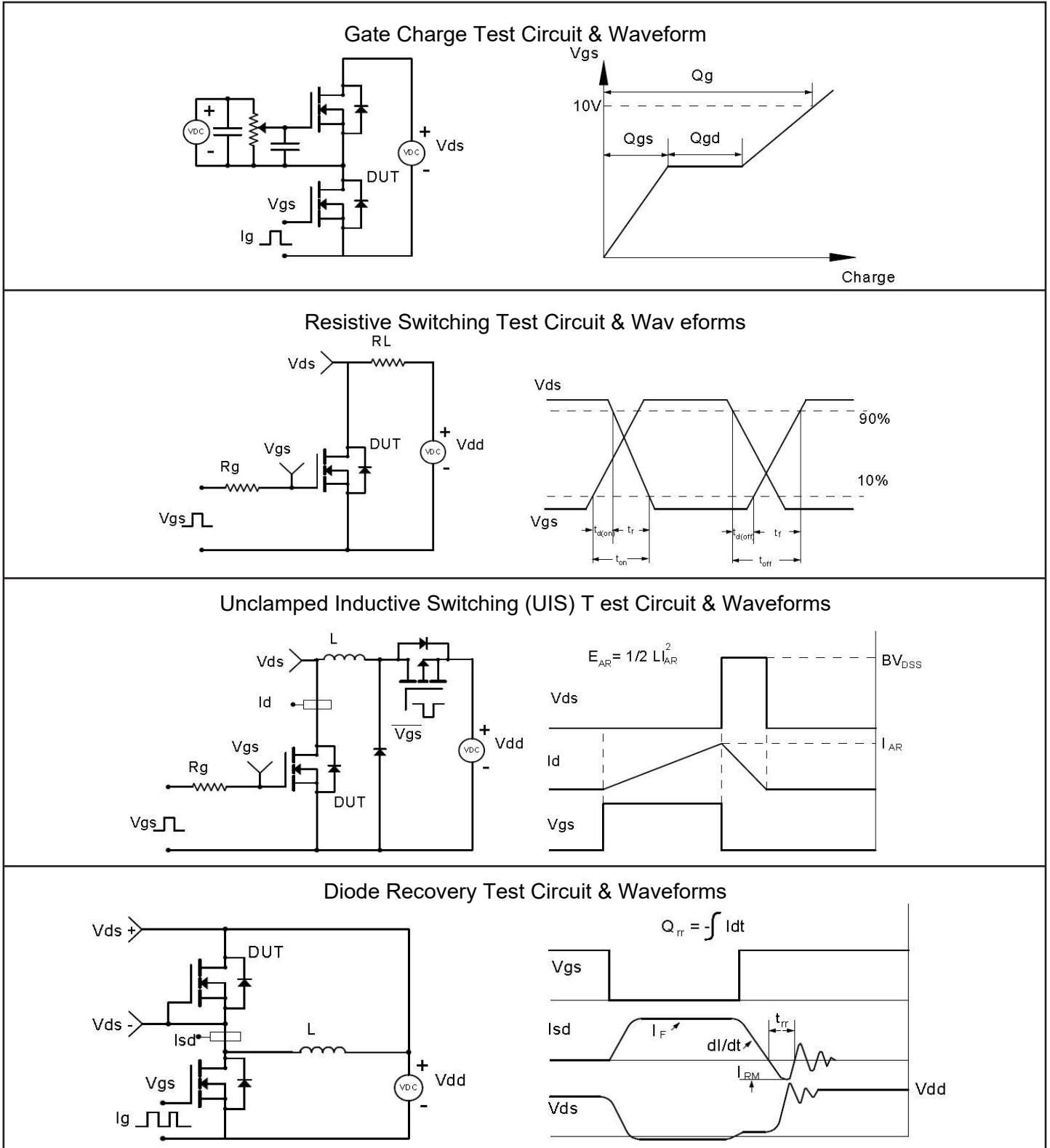

DFN5*6-8L Package Outline & Dimensions (Units: mm / in)

PDFN5*6-8L

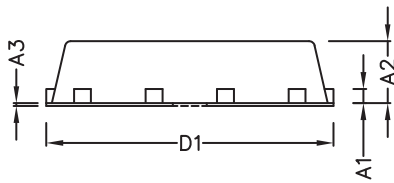

SIDE VIEW

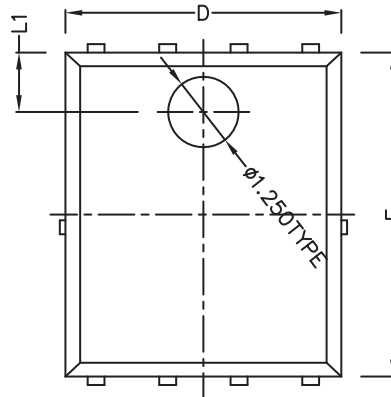

TOP VIEW

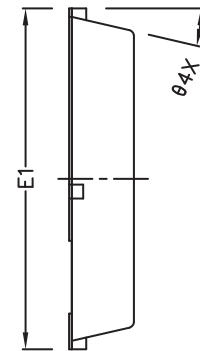

SIDE VIEW

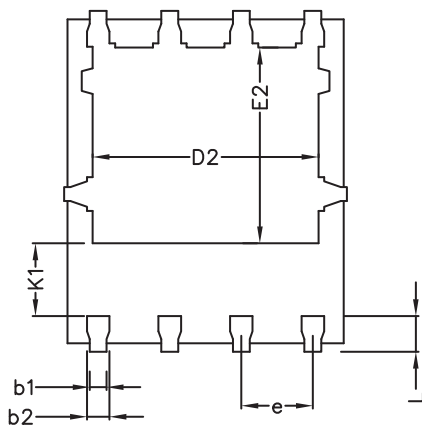

BOTTOM VIEW
OPTION 1

Symbol	Dimensions In Millimeters		Dimensions In Inches	
	Min	Max	Min	Max
A1	(0.254 BSC)		(0.0100 BSC)	
A2	1.000	1.100	0.0394	0.0433
A3	0.005	-	0.0001	-
b1	0.250	0.300	0.0098	0.0118
b2	0.350	0.400	0.0138	0.0157
D	4.800	4.900	0.1890	0.1929
D1	5.000	5.100	0.1969	0.2008
D2	3.910	4.010	0.1539	0.1579
E	5.650	5.750	0.2224	0.2263
E1	5.950	6.050	0.2342	0.2381
E2	3.375	3.475	0.1329	0.1368
e	(1.270 TYPE)		(0.0500 TYPE)	
L	0.530	0.630	0.0209	0.0248
L1	1.00 REF		0.0394 REF	
θ	13° TYPE		13° TYPE	
K1	1.235 REF		0.0486 REF	

Disclaimer

UNSEMI RESERVES THE RIGHT TO MAKE CHANGE ON OUR PRODUCTS , PRODUCTS SPECIFICATION AND DATA WITHOUT NOTICE TO IMPROVE RELIABILITY, FUNCTION OR DESIGN OR OTHERWISE.

UN SEMICONDUCTOR LIMITED its affiliates, agents, and employees, and all persons acting on its or their behalf (collectively, "UNSEMI") does not give any representations or warranties for any errors, inaccuracies or incompleteness contained in any datasheet or in any other disclosure relating to any product.

In no event shall UNSEMI be liable for any indirect, incidental, punitive, special or consequential damages (including any and all implied warranties, warranties of fitness for particular purpose, non-infringement and merchantability.) whether or not such damages are based on tort (including negligence), warranty, breach of contract or any other legal theory.

Statements regarding the suitability of products for certain types of applications are based on UNSEMI knowledge of typical requirements that are often placed on UNSEMI products in generic applications. Such statements are not binding, statements about the suitability of products for a particular application. It is the customer's responsibility to validate that a particular product with the properties described in the product specification is suitable for use in a particular application. Parameters provided in datasheets or specifications may vary in different applications and performance may vary over time. All operating parameters, including typical parameters, must be validated for each customer application by the customer's technical experts. Product specifications do not expand or otherwise modify UNSEMI's terms and conditions of purchase, including but not limited to the warranty expressed therein.

Unless otherwise agreed in writing, UNSEMI product is not designed, authorized or warranted to be suitable for use in medical life-saving, or life-sustaining application , nor in applications where failure or malfunction of a UNSEMI product can reasonably be expected to result in personal injury, death or severe property or environmental damage. UNSEMI and its suppliers accept no liability for inclusion or use of UNSEMI products in such equipment or applications and therefore such inclusion and/or use is at the customer's own risk.

All referenced brands, product names, service names and trademarks are the property of their respective owners.