

## Axial Lead Transient Voltage Suppressors (TVS)

**30KP Series    28 To 288 V    30000W**

### Description

The 30KP series is designed specifically to protect sensitive electronic equipment from voltage transients induced by lightning and other transient voltage events.

### Features

- u Glass passivated chip junction in P600 Package
- u Low leakage
- u Uni and Bidirectional unit
- u Excellent clamping capability
- u 30000W Peak power capability at 10 × 1000µs waveform Repetition rate (duty cycle):0.01%
- u Fast response time: typically less than 1.0ps from 0 Volts to  $V_{BR}$  min
- u Typical  $I_R$  less than 2µA above 73V.
- u High Temperature soldering: 260°C/40 seconds at terminals
- u Typical maximum temperature coefficient  $\Delta V_{BR} = 0.1\% \times V_{BR}@25^\circ\text{C} \times \Delta T$
- u Plastic package has Underwriters Laboratory Flammability 94V-0
- u Matte tin lead-free Plated
- u Halogen free and RoHS compliant
- u Typical failure mode is short from over-specified voltage or current
- u Whisker test is conducted based on JEDEC JESD201A per its table 4a and 4c
- u IEC-61000-4-2 ESD 15kV(Air), 8kV (Contact)
- u ESD protection of data lines in accordance with IEC 61000-4-2 (IEC801-2)
- u EFT protection of data lines in accordance with IEC 61000-4-4 (IEC801-4)

Uni-directional

Bi-directional

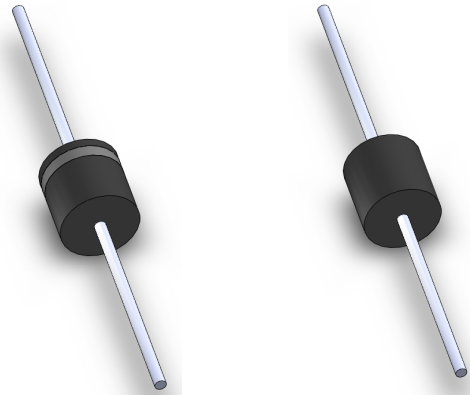

### Functional Diagram

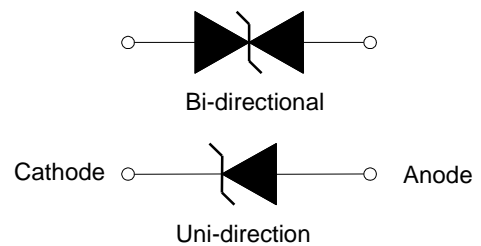

### Applications

TVS devices are ideal for the protection of I/O interfaces,  $V_{CC}$  bus and other vulnerable circuits used in Telecom, Computer, Industrial and Consumer electronic applications.

### Maximum Ratings ( $T_A=25^\circ\text{C}$ unless otherwise noted)

Parameter	Symbol	Value	Unit
Peak Pulse Power Dissipation with a 10/1000µs waveform (Fig.1)(Note 1), (Note 2)	$P_{PPM}$	20000	Watts
Peak Pulse Current with a 10/1000µs waveform.(Note1, Fig.3)	$I_{PP}$	See Next Table	Amps
Power Dissipation on Infinite Heat Sink at $T_L=75^\circ\text{C}$	$P_{M(AV)}$	8.0	Watt
Peak Forward Surge Current, 8.3ms Single Half Sine Wave (Note 3)	$I_{FSM}$	500	Amps
Operating junction and Storage Temperature Range.	$T_J, T_{STG}$	-55 to +150	$^\circ\text{C}$

### Notes:

1. Non-repetitive current pulse, per Fig. 3 and derated above  $T_A = 25^\circ\text{C}$  per Fig. 2.
2. Mounted on 5.0mm x 5.0mm (0.03mm thick) Copper Pads to each terminal.
3. 8.3ms single half sine-wave, or equivalent square wave, Duty cycle = 4 pulses per minutes maximum.
4.  $V_F < 3.5\text{V}$  for  $V_{BR} < 200\text{V}$  and  $V_F < 6.5\text{V}$  for  $V_{BR} > 201\text{V}$ .

## Axial Lead Transient Voltage Suppressors (TVS)

**30KP Series 28 To 288 V 30000W**

Part Number		Reverse Stand-Off Voltage $V_{RWM}$ (V)	Breakdown Voltage $V_{BR}$ (V) @ $I_T$	Test Current $I_T$ (mA)	Maximum Clamping Voltage $V_C$ @ $I_{PP}$ (V)	Maximum Peak Pulse Current $I_{PP}$ (A)	Maximum Reverse Leakage $I_R$ @ $V_{RWM}$ ( $\mu$ A)
Uni	Bi		MIN				
30KP28A	30KP28CA	28	31.28	50	50.0	606.0	5000
30KP30A	30KP30CA	30	33.51	50	55.2	548.9	5000
30KP33A	30KP33CA	33	36.90	50	58.5	517.9	5000
30KP36A	30KP36CA	36	40.20	50	61.8	490.3	5000
30KP39A	30KP39CA	39	43.60	20	67.2	450.9	2000
30KP42A	30KP42CA	42	46.90	10	72.0	420.8	1000
30KP43A	30KP43CA	43	48.00	10	73.0	415.1	1000
30KP45A	30KP45CA	45	50.30	5	77.4	391.5	250
30KP48A	30KP48CA	48	53.60	5	81.6	371.3	150
30KP51A	30KP51CA	51	57.00	5	86.4	350.7	50
30KP54A	30KP54CA	54	60.30	5	91.4	331.5	20
30KP58A	30KP58CA	58	64.80	5	92.4	327.9	20
30KP60A	30KP60CA	60	67.00	5	102.0	297.1	15
30KP64A	30KP64CA	64	71.50	5	104.0	291.3	10
30KP66A	30KP66CA	66	73.70	5	107.0	283.2	2
30KP70A	30KP70CA	70	78.20	5	109.0	278.0	2
30KP71A	30KP71CA	71	79.30	5	111.5	271.7	2
30KP72A	30KP72CA	72	80.40	5	114.0	265.8	2
30KP75A	30KP75CA	75	83.80	5	119.4	253.8	2
30KP78A	30KP78CA	78	87.10	5	129.0	234.9	2
30KP84A	30KP84CA	84	93.80	5	139.2	217.7	2
30KP90A	30KP90CA	90	100.50	5	146.4	207.0	2
30KP96A	30KP96CA	96	107.20	5	156.0	194.2	2
30KP102A	30KP102CA	102	113.90	5	165.6	183.0	2
30KP108A	30KP108CA	108	120.60	5	175.2	172.9	2
30KP120A	30KP120CA	120	134.00	5	194.4	155.9	2
30KP132A	30KP132CA	132	147.40	5	213.0	142.3	2
30KP144A	30KP144CA	144	160.80	5	223.2	135.8	2
30KP150A	30KP150CA	150	167.60	5	233.4	129.8	2
30KP156A	30KP156CA	156	174.30	5	245.0	123.7	2
30KP160A	30KP160CA	160	178.70	5	252.6	120.0	2
30KP168A	30KP168CA	168	187.70	5	272.4	111.2	2
30KP170A	30KP170CA	170	189.90	5	275.0	110.2	2
30KP180A	30KP180CA	180	201.10	5	290.4	104.3	2
30KP198A	30KP198CA	198	221.20	5	319.8	94.7	2
30KP216A	30KP216CA	216	241.30	5	348.6	86.9	2
30KP240A	30KP240CA	240	268.10	5	387.0	78.3	2
30KP258A	30KP258CA	258	188.20	5	416.4	72.8	2
30KP260A	30KP260CA	260	290.40	5	416.0	72.8	2
30KP270A	30KP270CA	270	301.60	5	436.2	69.5	2
30KP280A	30KP280CA	280	312.80	5	464.0	65.3	2
30KP288A	30KP288CA	288	321.70	5	469.9	64.5	2

**Note:**

- For Bi-Directional devices having  $V_R$  of 60 volts and under, the  $I_R$  limit is double

## Axial Lead Transient Voltage Suppressors (TVS)

30KP Series 28 To 288 V 30000W

Ratings and Characteristic Curves ( $T_A=25^\circ\text{C}$  unless otherwise noted)

Figure 1 - Peak Pulse Power Rating Curve

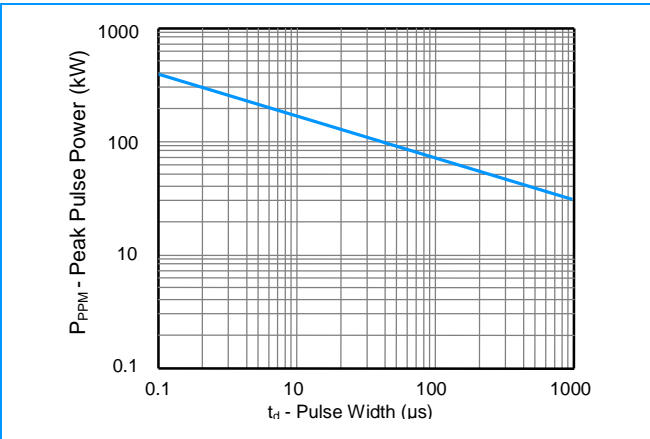

Figure 2 - Pulse Derating Curve

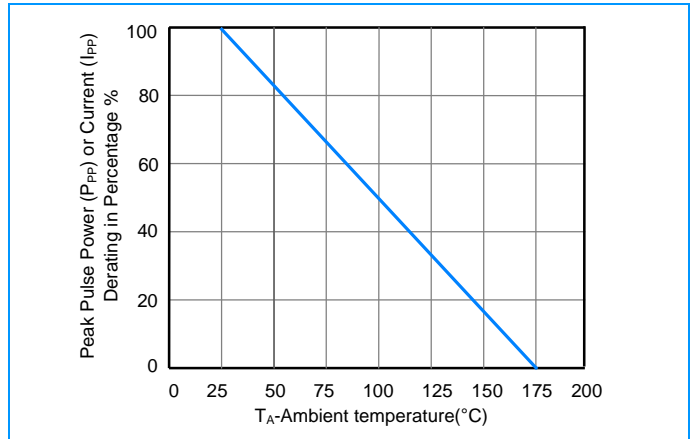

Figure 3 - Pulse Waveform

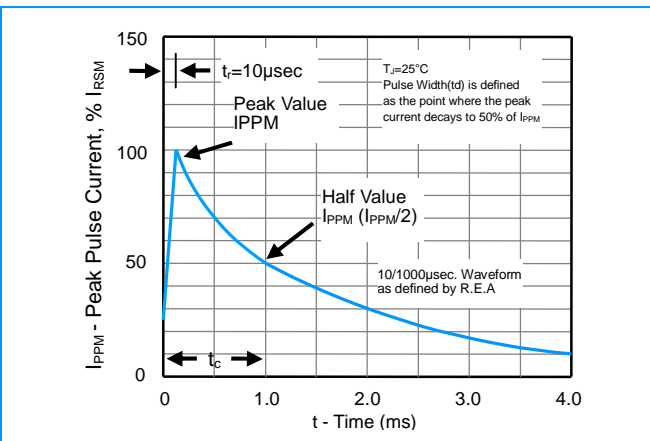

Figure 4 - Typical Junction Capacitance

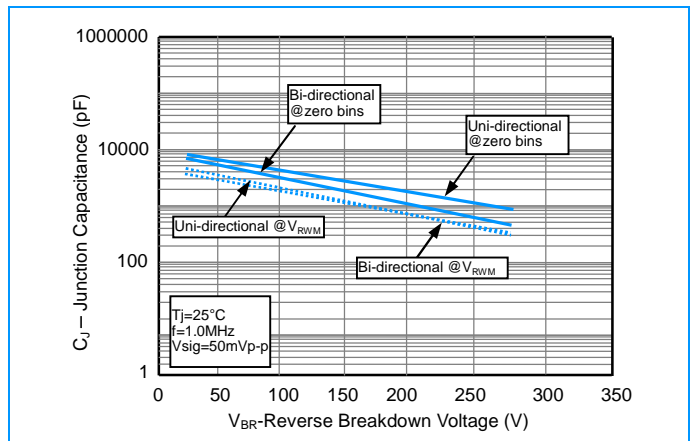

Figure 5 - Steady State Power Derating Curve

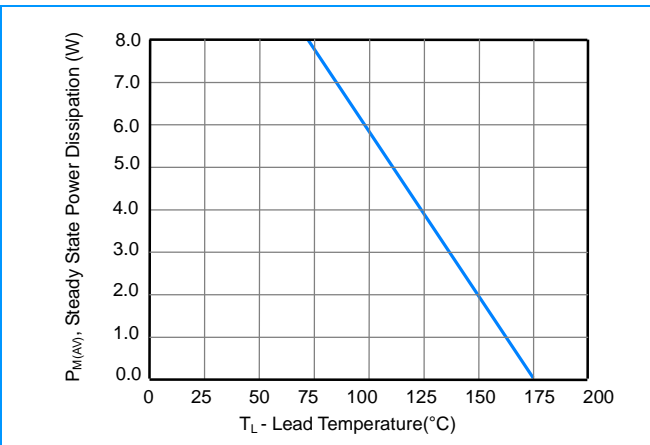
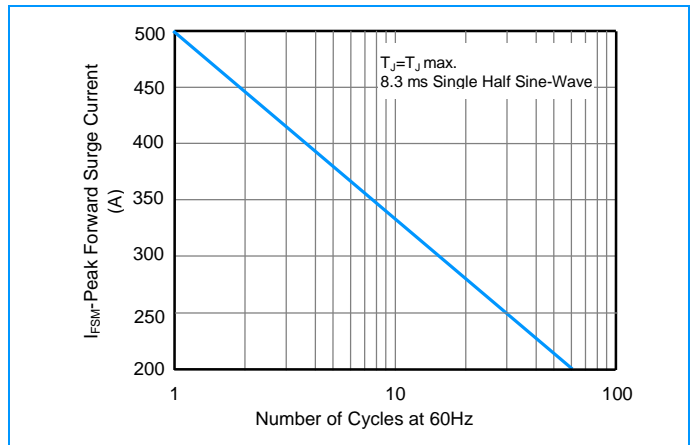

Figure 6 - Maximum Non-Repetitive Surge Current



## Axial Lead Transient Voltage Suppressors (TVS)

**30KP Series 28 To 288 V 30000W**

### I-V Curve Characteristics

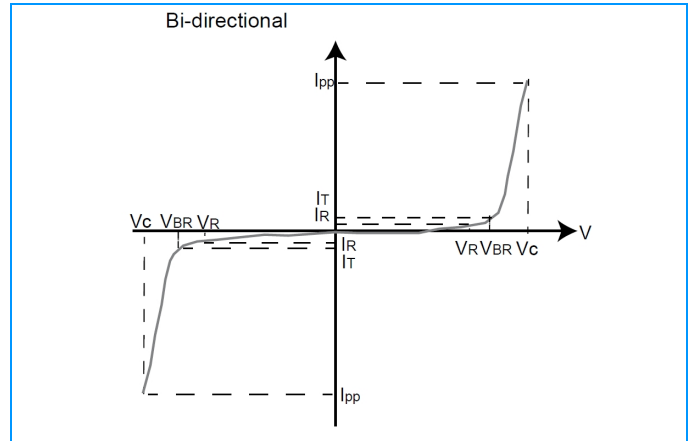
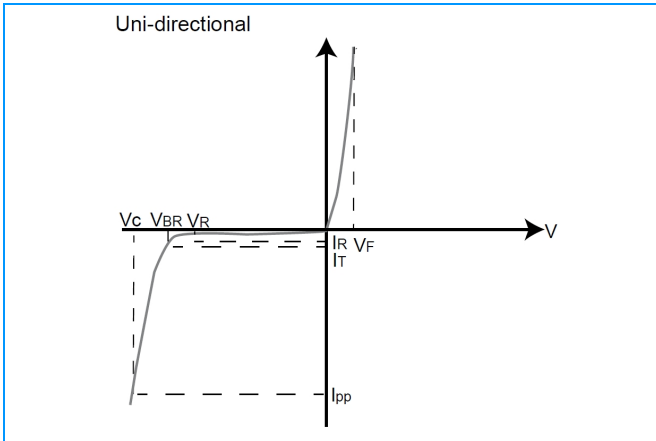

### Physical Specifications

<b>Weight</b>	0.07 ounce, 2.1gram
<b>Case</b>	JEDEC R-6/P600 Molded Plastic over glass passivated junction
<b>Polarity</b>	Color band denotes cathode except Bipolar
<b>Terminal</b>	Matte Tin-plated leads, Solderable per JESD22-B102D

### Environmental Specifications

<b>Temperature Cycle</b>	JESD22-A104
<b>Pressure Cooker</b>	JESD22-A102
<b>High Temp. Storage</b>	JESD22-A103
<b>HTRB</b>	JESD22-A108
<b>Thermal Shock</b>	JESD22-A106

### Soldering Parameters

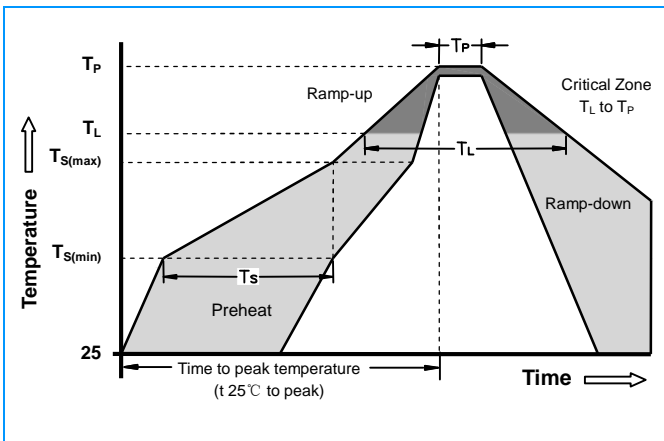

<b>Reflow Condition</b>		Lead-free assembly
<b>Pre Heat</b>	-Temperature Min ( $T_{s(min)}$ )	150°C
	-Temperature Max ( $T_{s(max)}$ )	200°C
	- Time (min to max) ( $t_s$ )	60 -180 Seconds
<b>Average ramp up rate ( Liquidus Temp <math>T_L</math>) to peak</b>		3°C/second max
<b><math>T_{s(max)}</math> to <math>T_L</math> - Ramp-up Rate</b>		3°C/second max
<b>Reflow</b>	- Temperature ( $T_L$ ) (Liquidus)	217°C
	- Time (min to max) ( $t_s$ )	60 -150 Seconds
<b>Peak Temperature (<math>T_P</math>)</b>		260 +0/-5°C
<b>Time within 5°C of actual peak Temperature (<math>t_p</math>)</b>		20 -40 Seconds
<b>Ramp-down Rate</b>		6°C/second max
<b>Time 25°C to peak Temperature (<math>T_P</math>)</b>		8 minutes Max
<b>Do not exceed</b>		280°C

## Axial Lead Transient Voltage Suppressors (TVS)

**30KP Series 28 To 288 V 30000W**

### Dimensions

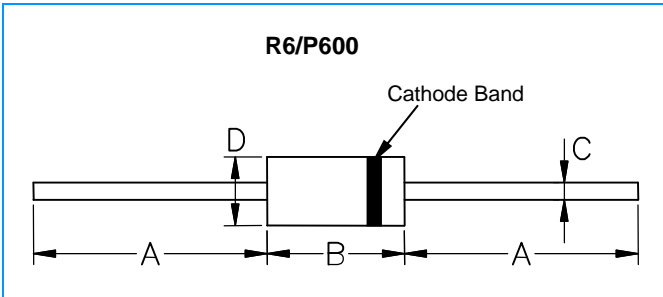

Dimensions	Inches		Millimeters	
	Min	Max	Min	Max
A	1.000	-	25.40	-
B	0.340	0.360	8.64	9.14
C	0.048	0.052	1.22	1.32
D	0.340	0.360	8.64	9.14

### Part Numbering

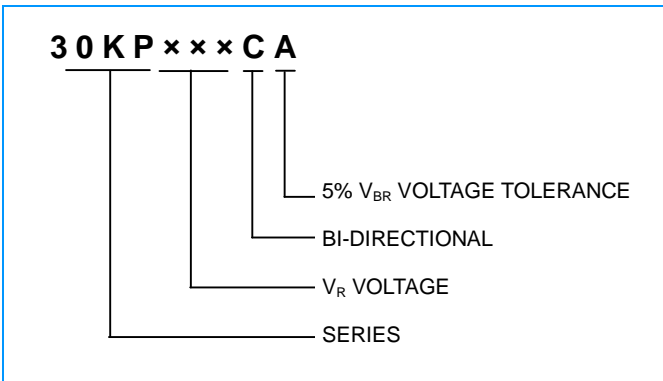

### Packaging

Part Number	Component Package	Quantity	Packaging Option
30KPXXXXX	R6/P600	200	Box

### Packaging Dimensions Unit: Inches (Millimeters)

