

Axial Lead Transient Voltage Suppressors (TVS)

SA Series 5.0 To 190 V 500W

Description

The SA series is designed specifically to protect sensitive electronic equipment from voltage transients induced by lightning and other transient voltage events.

Features

- u Glass passivated chip junction in DO-15 Package
- u Low leakage
- u Uni and Bidirectional unit
- u Excellent clamping capability
- u 500W Peak power capability at 10 × 1000µs waveform Repetition rate (duty cycle):0.01%
- u Fast response time: typically less than 1.0ps from 0 Volts to V_{BR} min
- u Typical I_R less than 5µA above 12V.
- u High Temperature soldering: 260°C/40 seconds at terminals
- u Typical maximum temperature coefficient $\Delta V_{BR} = 0.1\% \times V_{BR}@25^\circ\text{C} \times \Delta T$
- u Plastic package has Underwriters Laboratory Flammability 94V-0
- u Matte tin lead-free Plated
- u Halogen free and RoHS compliant
- u Typical failure mode is short from over-specified voltage or current
- u Whisker test is conducted based on JEDEC JESD201A per its table 4a and 4c
- u IEC-61000-4-2 ESD 15kV(Air), 8kV (Contact)
- u ESD protection of data lines in accordance with IEC 61000-4-2 (IEC801-2)
- u EFT protection of data lines in accordance with IEC 61000-4-4 (IEC801-4)

Uni-directional

Bi-directional

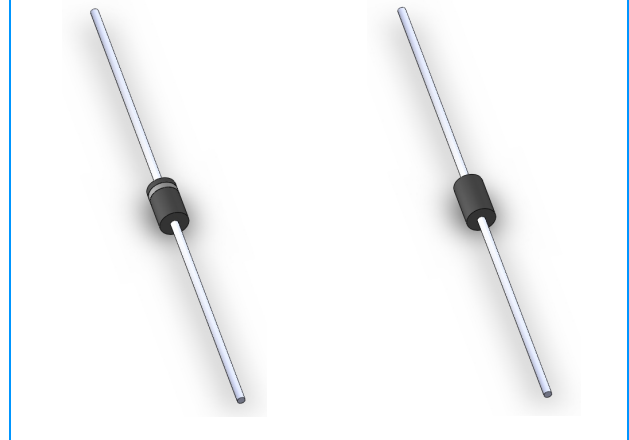

Functional Diagram

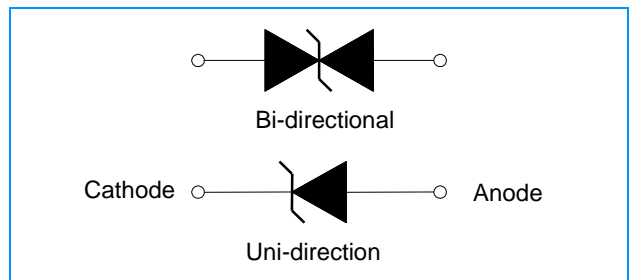

Applications

TVS devices are ideal for the protection of I/O interfaces, V_{CC} bus and other vulnerable circuits used in Telecom, Computer, Industrial and Consumer electronic applications.

Maximum Ratings ($T_A=25^\circ\text{C}$ unless otherwise noted)

Parameter	Symbol	Value	Unit
Peak Pulse Power Dissipation with a 10/1000µs waveform (Fig.1)(Note 1), (Note 2)	P_{PPM}	500	Watts
Peak Pulse Current with a 10/1000µs waveform.(Note1, Fig.3)	I_{PP}	See Next Table	Amps
Power Dissipation on Infinite Heat Sink at $T_L=75^\circ\text{C}$	$P_{M(AV)}$	3.0	Watt
Peak Forward Surge Current, 8.3ms Single Half Sine Wave (Note 3)	I_{FSM}	70	Amps
Maximum Instantaneous Forward Voltage at 25A for Unidirectional Only (Note 4)	V_F	3.5/5.0	Voltage
Operating junction and Storage Temperature Range.	T_J, T_{STG}	-55 to +150	$^\circ\text{C}$

Notes:

1. Non-repetitive current pulse, per Fig. 3 and derated above $T_A = 25^\circ\text{C}$ per Fig. 2.
2. Mounted on 5.0mm x 5.0mm (0.03mm thick) Copper Pads to each terminal.
3. 8.3ms single half sine-wave, or equivalent square wave, Duty cycle = 4 pulses per minutes maximum.
4. $V_F < 3.5\text{V}$ for $V_{BR} < 200\text{V}$ and $V_F < 6.5\text{V}$ for $V_{BR} > 201\text{V}$.

Axial Lead Transient Voltage Suppressors (TVS)

SA Series 5.0 To 190 V 500W
Electrical Characteristics (T_A=25°C unless otherwise noted)

Part Number		Reverse Stand-Off Voltage V _{RWM} (V)	Breakdown Voltage V _{BR} (V) @I _T		Test Current I _T (mA)	Maximum Clamping Voltage V _C @I _{PP} (V)	Maximum Peak Pulse Current I _{PP} (A)	Maximum Reverse Leakage I _R @V _{RWM} (μA)
Uni	Bi		MIN	MAX				
SA5.0	SA5.0C	5.0	6.40	7.30	10	9.6	52.08	600
SA5.0A	SA5.0CA	5.0	6.40	7.00	10	9.2	54.35	600
SA6.0	SA6.0C	6.0	6.67	8.15	10	11.4	43.86	600
SA6.0A	SA6.0CA	6.0	6.67	7.37	10	10.3	48.54	600
SA6.5	SA6.5C	6.5	7.22	8.82	10	12.3	40.65	400
SA6.5A	SA6.5CA	6.5	7.22	7.98	10	11.2	44.64	400
SA7.0	SA7.0C	7.0	7.78	9.51	10	13.3	37.59	150
SA7.0A	SA7.0CA	7.0	7.78	8.60	10	12.0	41.67	150
SA7.5	SA7.5C	7.5	8.33	10.20	1	14.3	34.97	50
SA7.5A	SA7.5CA	7.5	8.33	9.21	1	12.9	38.76	50
SA8.0	SA8.0C	8.0	8.89	10.90	1	15.0	33.33	25
SA8.0A	SA8.0CA	8.0	8.89	9.83	1	13.6	36.76	25
SA8.5	SA8.5C	8.5	9.44	11.50	1	15.9	31.45	5
SA8.5A	SA8.5CA	8.5	9.44	10.40	1	14.4	34.72	5
SA9.0	SA9.0C	9.0	10.00	12.20	1	16.9	29.59	5
SA9.0A	SA9.0CA	9.0	10.00	11.10	1	15.4	32.47	5
SA10	SA10C	10.0	11.10	13.60	1	18.8	26.60	5
SA10A	SA10CA	10.0	11.10	12.30	1	17.0	29.41	5
SA11	SA11C	11.0	12.20	14.90	1	20.1	24.88	5
SA11A	SA11CA	11.0	12.20	13.50	1	18.2	27.47	5
SA12	SA12C	12.0	13.30	16.30	1	22.0	22.73	5
SA12A	SA12CA	12.0	13.30	14.70	1	19.9	25.13	5
SA13	SA13C	13.0	14.40	17.60	1	23.8	21.01	5
SA13A	SA13CA	13.0	14.40	15.90	1	21.5	23.26	5
SA14	SA14C	14.0	15.60	19.10	1	25.8	19.38	5
SA14A	SA14CA	14.0	15.60	17.20	1	23.2	21.55	5
SA15	SA15C	15.0	16.70	20.40	1	26.9	18.59	5
SA15A	SA15CA	15.0	16.70	18.50	1	24.4	20.49	5
SA16	SA16C	16.0	17.80	21.80	1	28.8	17.36	5
SA16A	SA16CA	16.0	17.80	19.70	1	26.0	19.23	5
SA17	SA17C	17.0	18.90	23.10	1	30.5	16.39	5
SA17A	SA17CA	17.0	18.90	20.90	1	27.6	18.12	5
SA18	SA18C	18.0	20.00	24.40	1	32.2	15.53	5
SA18A	SA18CA	18.0	20.00	22.10	1	29.2	17.12	5
SA19	SA19C	19.0	21.13	25.76	1	34.0	14.70	5
SA19A	SA19CA	19.0	21.10	23.30	1	30.8	16.24	5
SA20	SA20C	20.0	22.20	27.10	1	35.8	13.97	5
SA20A	SA20CA	20.0	22.20	24.50	1	32.4	15.43	5
SA22	SA22C	22.0	24.40	29.80	1	39.4	12.69	5
SA22A	SA22CA	22.0	24.40	26.90	1	35.5	14.08	5
SA24	SA24C	24.0	26.70	32.60	1	43.0	11.63	5
SA24A	SA24CA	24.0	26.70	29.50	1	38.9	12.85	5
SA26	SA26C	26.0	28.90	35.30	1	46.6	10.73	5
SA26A	SA26CA	26.0	28.90	31.90	1	42.1	11.88	5
SA28	SA28C	28.0	31.10	38.00	1	50.0	10.00	5
SA28A	SA28CA	28.0	31.10	34.40	1	45.4	11.01	5
SA30	SA30C	30.0	33.30	40.70	1	53.5	9.35	5
SA30A	SA30CA	30.0	33.30	36.80	1	48.4	10.33	5
SA33	SA33C	33.0	36.70	44.90	1	59.0	8.47	5
SA33A	SA33CA	33.0	36.70	40.60	1	53.3	9.38	5
SA36	SA36C	36.0	40.00	48.90	1	64.3	7.78	5
SA36A	SA36CA	36.0	40.00	44.20	1	58.1	8.61	5
SA40	SA40C	40.0	44.40	54.30	1	71.4	7.00	5
SA40A	SA40CA	40.0	44.40	49.10	1	64.5	7.75	5

Axial Lead Transient Voltage Suppressors (TVS)

SA Series 5.0 To 190 V 500W
Electrical Characteristics (T_A=25°C unless otherwise noted) (Continue)

Part Number		Reverse Stand-Off Voltage V _{RWM} (V)	Breakdown Voltage V _{BR} (V) @I _T		Test Current I _T (mA)	Maximum Clamping Voltage V _C @I _{PP} (V)	Maximum Peak Pulse Current I _{PP} (A)	Maximum Reverse Leakage I _R @V _{RWM} (μA)
Uni	Bi		MIN	MAX				
SA43	SA43C	43.0	47.80	58.40	1	76.7	6.52	5
SA43A	SA43CA	43.0	47.80	52.80	1	69.4	7.20	5
SA45	SA45C	45.0	50.00	61.10	1	80.3	6.23	5
SA45A	SA45CA	45.0	50.00	55.30	1	72.7	6.88	5
SA48	SA48C	48.0	53.30	65.10	1	85.5	5.85	5
SA48A	SA48CA	48.0	53.30	58.90	1	77.4	6.46	5
SA51	SA51C	51.0	56.70	69.30	1	91.1	5.49	5
SA51A	SA51CA	51.0	56.70	62.70	1	82.4	6.07	5
SA54	SA54C	54.0	60.00	73.30	1	96.3	5.19	5
SA54A	SA54CA	54.0	60.00	66.30	1	87.1	5.74	5
SA58	SA58C	58.0	64.40	78.70	1	103.0	4.85	5
SA58A	SA58CA	58.0	64.40	71.20	1	93.6	5.34	5
SA60	SA60C	60.0	66.70	81.50	1	107.0	4.67	5
SA60A	SA60CA	60.0	66.70	73.70	1	96.8	5.17	5
SA64	SA64C	64.0	71.10	86.90	1	114.0	4.39	5
SA64A	SA64CA	64.0	71.10	78.60	1	103.0	4.85	5
SA70	SA70C	70.0	77.80	95.10	1	125.0	4.00	5
SA70A	SA70CA	70.0	77.80	86.00	1	113.0	4.42	5
SA75	SA75C	75.0	83.30	102.00	1	134.0	3.37	5
SA75A	SA75CA	75.0	83.30	92.10	1	121.0	4.13	5
SA78	SA78C	78.0	86.70	106.00	1	139.0	3.60	5
SA78A	SA78CA	78.0	86.70	95.80	1	126.0	3.97	5
SA80	SA80C	80.0	88.96	108.80	1	143.2	3.49	5
SA80A	SA80CA	80.0	88.80	97.60	1	129.6	3.86	5
SA85	SA85C	85.0	94.40	115.00	1	151.0	3.31	5
SA85A	SA85CA	85.0	94.40	104.00	1	137.0	3.65	5
SA90	SA90C	90.0	100.00	122.00	1	160.0	3.13	5
SA90A	SA90CA	90.0	100.00	111.00	1	146.0	3.42	5
SA100	SA100C	100.0	111.00	136.00	1	179.0	2.79	5
SA100A	SA100CA	100.0	111.00	123.00	1	162.0	3.09	5
SA110	SA110C	110.0	122.00	149.00	1	196.0	2.55	5
SA110A	SA110CA	110.0	122.00	135.00	1	177.0	2.82	5
SA120	SA120C	120.0	133.00	163.00	1	214.0	2.34	5
SA120A	SA120CA	120.0	133.00	147.00	1	193.0	2.59	5
SA130	SA130C	130.0	144.00	176.00	1	231.0	2.16	5
SA130A	SA130CA	130.0	144.00	159.00	1	209.0	2.39	5
SA140	SA140C	140.0	155.68	190.40	1	250.6	2.00	5
SA140A	SA140CA	140.0	155.00	171.00	1	226.8	2.20	5
SA150	SA150C	150.0	167.00	204.00	1	268.0	1.87	5
SA150A	SA150CA	150.0	167.00	185.00	1	243.0	2.06	5
SA160	SA160C	160.0	178.00	218.00	1	287.0	1.74	5
SA160A	SA160CA	160.0	178.00	197.00	1	259.0	1.93	5
SA170	SA170C	170.0	189.00	231.00	1	304.0	1.64	5
SA170A	SA170CA	170.0	189.00	209.00	1	275.0	1.82	5
SA180	SA180C	180.0	201.00	244.80	1	322.2	1.55	5
SA180A	SA180CA	180.0	201.00	220.00	1	291.6	1.71	5
SA190	SA190C	190.0	211.21	258.40	1	340.1	1.47	5
SA190A	SA190CA	190.0	211.00	232.00	1	307.8	1.62	5

Note:

1. Suffix 'A' denotes 5% tolerance device. Without 'A' denotes 10% tolerance device
2. Add suffix 'C' or 'CA' after part number to specify Bi-directional devices
3. For Bi-Directional devices having V_R of 10 volts and under, the I_R limit is double

Axial Lead Transient Voltage Suppressors (TVS)

SA Series 5.0 To 190 V 500W

Ratings and Characteristic Curves ($T_A=25^\circ\text{C}$ unless otherwise noted)

Figure 1 - Peak Pulse Power Rating Curve

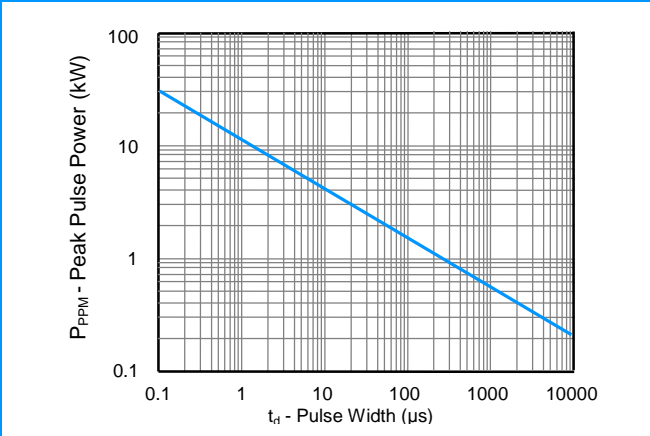

Figure 2 - Pulse Derating Curve

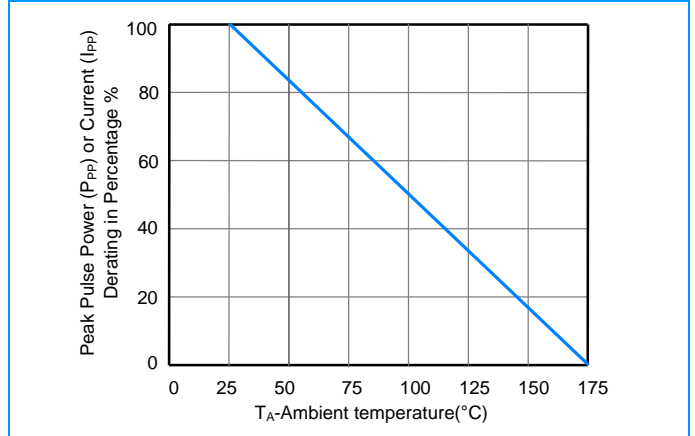

Figure 3 - Pulse Waveform

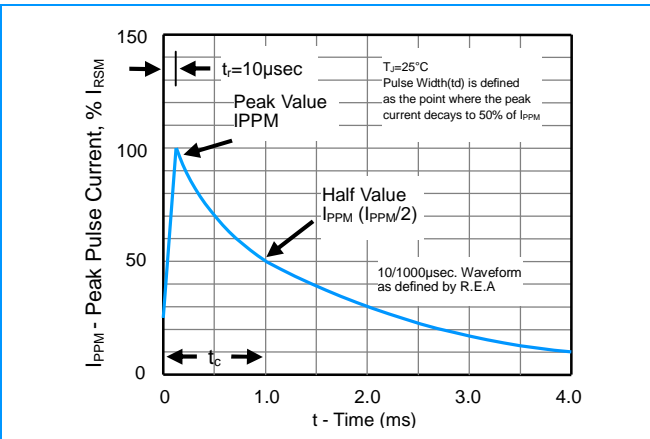

Figure 4 - Typical Junction Capacitance

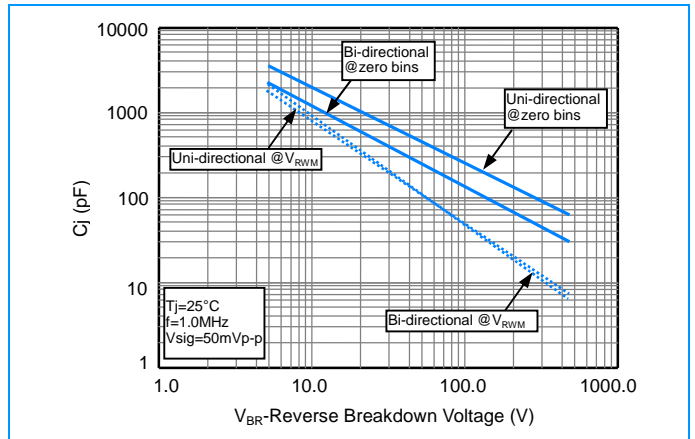

Figure 5 - Steady State Power Derating Curve

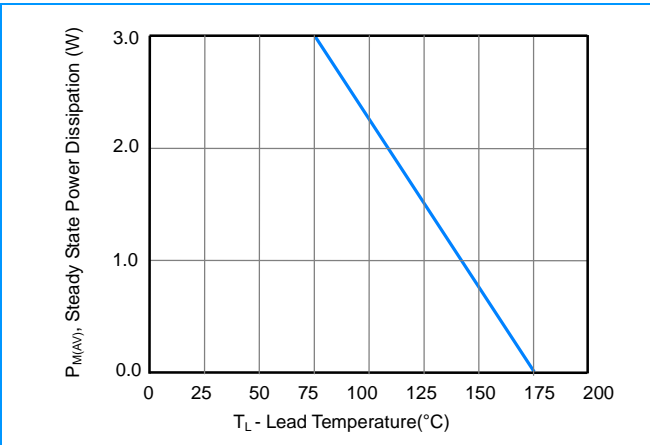
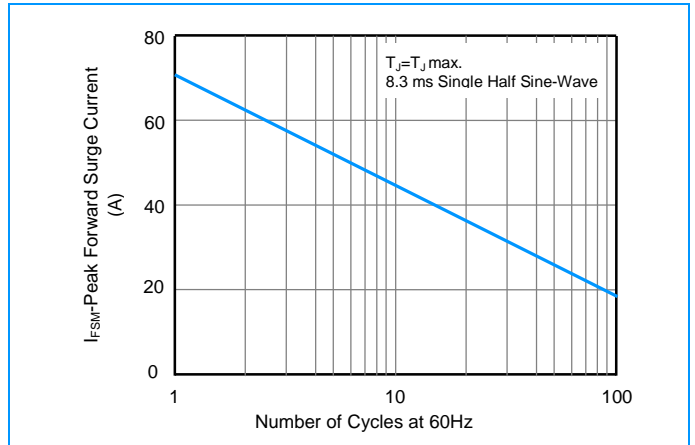

Figure 6 - Maximum Non-Repetitive Surge Current



Axial Lead Transient Voltage Suppressors (TVS)

SA Series 5.0 To 190 V 500W

I-V Curve Characteristics

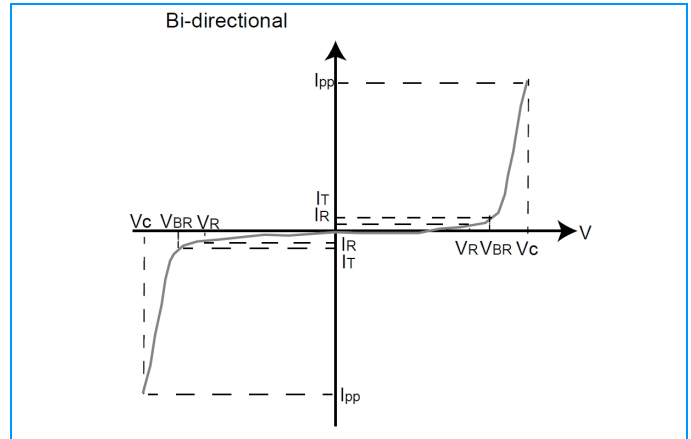
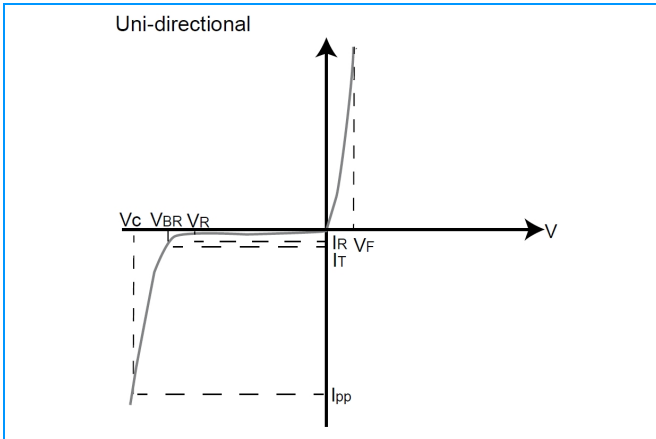

Physical Specifications

Weight	0.015 ounce, 0.4 gram
Case	JEDEC DO-204AC (DO-15) Molded Plastic over glass passivated junction
Polarity	Color band denotes cathode except Bipolar
Terminal	Matte Tin-plated leads, Solderable per JESD22-B102D

Environmental Specifications

Temperature Cycle	JESD22-A104
Pressure Cooker	JESD22-A102
High Temp. Storage	JESD22-A103
HTRB	JESD22-A108
Thermal Shock	JESD22-A106

Soldering Parameters

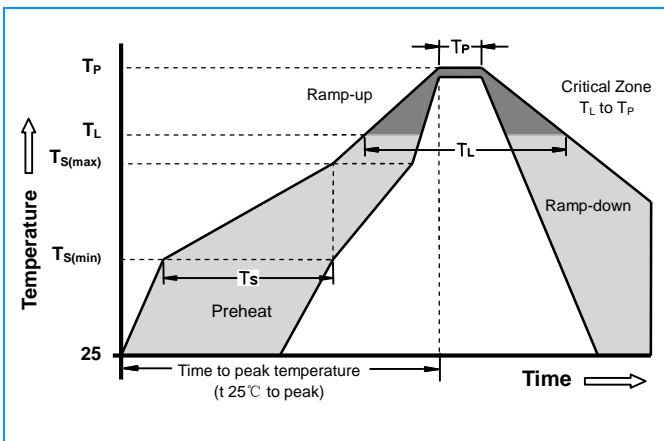

Reflow Condition		Lead-free assembly
Pre Heat	-Temperature Min ($T_{s(min)}$)	150°C
	-Temperature Max ($T_{s(max)}$)	200°C
	- Time (min to max) (t_s)	60 -180 Seconds
Average ramp up rate (Liquidus Temp T_L) to peak		3°C/second max
$T_{s(max)}$ to T_L - Ramp-up Rate		3°C/second max
Reflow	- Temperature (T_L) (Liquidus)	217°C
	- Time (min to max) (t_s)	60 -150 Seconds
Peak Temperature (T_p)		260 +0/-5°C
Time within 5°C of actual peak Temperature (t_p)		20 -40 Seconds
Ramp-down Rate		6°C/second max
Time 25°C to peak Temperature (T_p)		8 minutes Max
Do not exceed		280°C

Axial Lead Transient Voltage Suppressors (TVS)

SA Series 5.0 To 190 V 500W

Dimensions

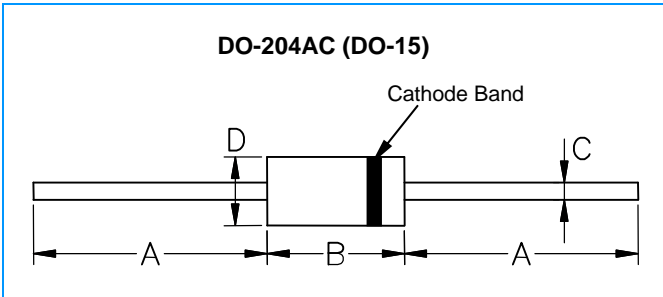

Dimensions	Inches		Millimeters	
	Min	Max	Min	Max
A	1.000	-	25.40	-
B	0.230	0.300	5.85	7.63
C	0.028	0.033	0.71	0.84
D	0.102	0.142	2.60	3.61

Part Numbering

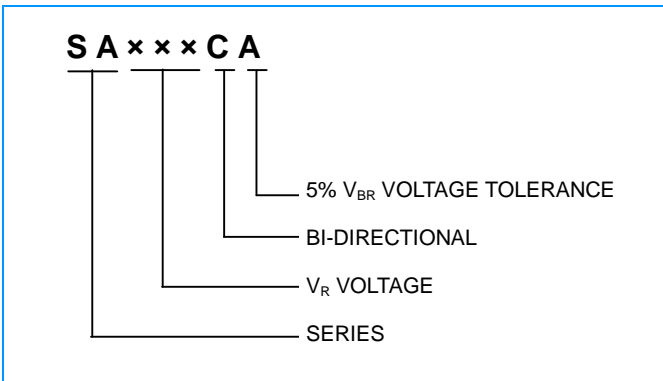

Packaging

Part Number	Component Package	Quantity	Packaging Option
SAXXXXX	DO-204AC (DO-15)	2000	Box

Packaging Dimensions Unit: Inches (Millimeters)

