

Surface Mount Transient Voltage Suppressors (TVS)

P6SMB Series 6.8 To 600 V 600W

Description

The P6SMB series is designed specifically to protect sensitive electronic equipment from voltage transients induced by lightning and other transient voltage events.

Features

- u For surface mounted applications in order to optimize board space
- u Low leakage
- u Uni and Bidirectional unit
- u Glass passivated junction
- u Low inductance
- u Excellent clamping capability
- u 600W Peak power capability at 10 × 1000μs waveform Repetition rate (duty cycle):0.01%
- u Fast response time: typically less than 1.0ps from 0 Volts to V_{BR} min
- u Typical I_R less than 5μA above 12V.
- u High Temperature soldering: 260°C/40 seconds at terminals
- u Typical maximum temperature coefficient $\Delta V_{BR} = 0.1\% \times V_{BR}@25^\circ\text{C} \times \Delta T$
- u Plastic package has Underwriters Laboratory Flammability 94V-0
- u Matte tin lead-free Plated
- u Halogen free and RoHS compliant
- u Typical failure mode is short from over-specified voltage or current
- u Whisker test is conducted based on JEDEC JESD201A per its table 4a and 4c
- u IEC-61000-4-2 ESD 15kV(Air), 8kV (Contact)
- u ESD protection of data lines in accordance with IEC 61000-4-2 (IEC801-2)
- u EFT protection of data lines in accordance with IEC 61000-4-4 (IEC801-4)

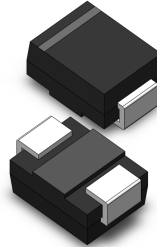
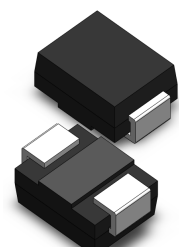
Uni-directional

Bi-directional

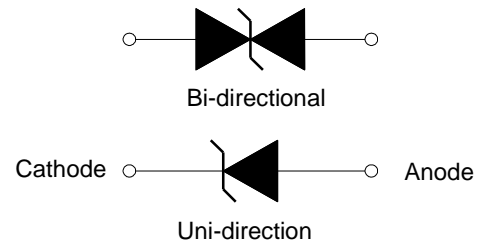
Functional Diagram



Applications

TVS devices are ideal for the protection of I/O interfaces, V_{CC} bus and other vulnerable circuits used in Telecom, Computer, Industrial and Consumer electronic applications.

Maximum Ratings ($T_A=25^\circ\text{C}$ unless otherwise noted)

Parameter	Symbol	Value	Unit
Peak Pulse Power Dissipation with a 10/1000μs waveform (Fig.1)(Note 1), (Note 2)	P_{PPM}	600	Watts
Peak Pulse Current with a 10/1000μs waveform.(Note1, Fig.3)	I_{PP}	See Next Table	Amps
Power Dissipation on Infinite Heat Sink at $T_L=75^\circ\text{C}$	$P_{M(AV)}$	5.0	Watt
Peak Forward Surge Current, 8.3ms Single Half Sine Wave (Note 3)	I_{FSM}	100	Amps
Maximum Instantaneous Forward Voltage at 25A for Unidirectional Only (Note 4)	V_F	3.5/5.0	Voltage
Operating junction and Storage Temperature Range.	T_J, T_{STG}	-55 to +150	$^\circ\text{C}$

Notes:

1. Non-repetitive current pulse, per Fig. 3 and derated above $T_A = 25^\circ\text{C}$ per Fig. 2.
2. Mounted on 5.0mm x 5.0mm (0.03mm thick) Copper Pads to each terminal.
3. 8.3ms single half sine-wave, or equivalent square wave, Duty cycle = 4 pulses per minutes maximum.
4. $V_F < 3.5\text{V}$ for $V_{BR} < 200\text{V}$ and $V_F < 6.5\text{V}$ for $V_{BR} > 201\text{V}$.

Surface Mount Transient Voltage Suppressors (TVS)

P6SMB Series 6.8 To 600 V 600W
Electrical Characteristics (T_A=25°C unless otherwise noted)

Part Number		Marking		Reverse Stand-Off Voltage V _{RWM} (V)	Breakdown Voltage V _{BR} (V) @I _T		Test Current I _T (mA)	Maximum Clamping Voltage V _C @I _{PP} (V)	Maximum Peak Pulse Current I _{PP} (A)	Maximum Reverse Leakage I _R @V _{RWM} (μA)
Uni	Bi	Uni	Bi		MIN	MAX				
P6SMB6.8A	P6SMB6.8CA	6V8A	6V8C	5.8	6.46	7.14	10	10.5	57.14	1000
P6SMB7.5A	P6SMB7.5CA	7V5A	7V5C	6.4	7.13	7.88	10	11.3	53.10	500
P6SMB8.2A	P6SMB8.2CA	8V2A	8V2C	7.0	7.79	8.61	10	12.1	49.59	200
P6SMB9.1A	P6SMB9.1CA	9V1A	9V1C	7.8	8.65	9.56	1	13.4	44.78	50
P6SMB10A	P6SMB10CA	10A	10C	8.6	9.50	10.50	1	14.5	41.38	10
P6SMB11A	P6SMB11CA	11A	11C	9.4	10.45	11.55	1	15.6	38.46	5
P6SMB12A	P6SMB12CA	12A	12C	10.2	11.40	12.60	1	16.7	35.93	5
P6SMB13A	P6SMB13CA	13A	13C	11.1	12.35	13.65	1	18.2	32.97	5
P6SMB15A	P6SMB15CA	15A	15C	12.8	14.25	15.75	1	21.2	28.30	5
P6SMB16A	P6SMB16CA	16A	16C	13.6	15.20	16.80	1	22.5	26.67	5
P6SMB18A	P6SMB18CA	18A	18C	15.3	17.10	18.90	1	25.2	23.81	5
P6SMB20A	P6SMB20CA	20A	20C	17.1	19.00	21.00	1	27.7	21.66	5
P6SMB22A	P6SMB22CA	22A	22C	18.8	20.90	23.10	1	30.6	19.61	5
P6SMB24A	P6SMB24CA	24A	24C	20.5	22.80	25.20	1	33.2	18.07	5
P6SMB27A	P6SMB27CA	27A	27C	23.1	25.65	28.35	1	37.5	16.00	5
P6SMB30A	P6SMB30CA	30A	30C	25.6	28.50	31.50	1	41.4	14.49	5
P6SMB33A	P6SMB33CA	33A	33C	28.2	31.35	34.65	1	45.7	13.13	5
P6SMB36A	P6SMB36CA	36A	36C	30.8	34.20	37.80	1	49.9	12.02	5
P6SMB39A	P6SMB39CA	39A	39C	33.3	37.05	40.95	1	53.9	11.13	5
P6SMB43A	P6SMB43CA	43A	43C	36.8	40.85	45.15	1	59.3	10.12	5
P6SMB47A	P6SMB47CA	47A	47C	40.2	44.65	49.35	1	64.8	9.26	5
P6SMB51A	P6SMB51CA	51A	51C	43.6	48.45	53.55	1	70.1	8.56	5
P6SMB56A	P6SMB56CA	56A	56C	47.8	53.20	58.80	1	77.0	7.79	5
P6SMB62A	P6SMB62CA	62A	62C	53.0	58.90	65.10	1	85.0	7.06	5
P6SMB68A	P6SMB68CA	68A	68C	58.1	64.60	71.40	1	92.0	6.52	5
P6SMB75A	P6SMB75CA	75A	75C	64.1	71.25	78.75	1	103.0	5.83	5
P6SMB82A	P6SMB82CA	82A	82C	70.1	77.90	86.10	1	113.0	5.31	5
P6SMB91A	P6SMB91CA	91A	91C	77.8	86.45	95.55	1	125.0	4.80	5
P6SMB100A	P6SMB100CA	100A	100C	85.5	95.00	105.00	1	137.0	4.38	5
P6SMB110A	P6SMB110CA	110A	110C	94.0	104.50	115.50	1	152.0	3.95	5
P6SMB120A	P6SMB120CA	120A	120C	102.0	114.00	126.00	1	165.0	3.64	5
P6SMB130A	P6SMB130CA	130A	130C	111.0	123.50	136.50	1	179.0	3.35	5
P6SMB150A	P6SMB150CA	150A	150C	128.0	142.50	157.50	1	207.0	2.90	5
P6SMB160A	P6SMB160CA	160A	160C	136.0	152.00	168.00	1	219.0	2.74	5
P6SMB170A	P6SMB170CA	170A	170C	145.0	161.50	178.50	1	234.0	2.56	5
P6SMB180A	P6SMB180CA	180A	180C	154.0	171.00	189.00	1	246.0	2.44	5
P6SMB200A	P6SMB200CA	200A	200C	171.0	190.00	210.00	1	274.0	2.19	5
P6SMB220A	P6SMB220CA	220A	220C	185.0	209.00	231.00	1	328.0	1.83	5
P6SMB250A	P6SMB250CA	250A	250C	214.0	237.50	262.50	1	344.0	1.74	5
P6SMB300A	P6SMB300CA	300A	300C	256.0	285.00	315.00	1	414.0	1.45	5
P6SMB350A	P6SMB350CA	350A	350C	299.3	332.50	367.50	1	482.0	1.24	5
P6SMB380A	P6SMB380CA	380A	380C	324.9	361.00	399.00	1	524.4	1.14	5
P6SMB400A	P6SMB400CA	400A	400C	342.0	380.00	420.00	1	552.0	1.09	5
P6SMB440A	P6SMB440CA	440A	440C	376.2	418.00	462.00	1	607.2	0.99	5
P6SMB500A	P6SMB500CA	500A	500C	427.5	475.00	525.00	1	690.0	0.87	5
P6SMB520A	P6SMB520CA	520A	520C	444.6	494.00	546.00	1	717.6	0.84	5
P6SMB550A	P6SMB550CA	550A	550C	470.3	522.50	577.50	1	759.0	0.79	5
P6SMB600A	P6SMB600CA	600A	600C	513.0	570.00	630.00	1	828.0	0.72	5

Note:

1. Suffix 'A' denotes 5% tolerance device. Without 'A' denotes 10% tolerance device
2. Add suffix 'C' or 'CA' after part number to specify Bi-directional devices
3. For Bi-Directional devices having V_R of 10 volts and under, the I_R limit is double

Surface Mount Transient Voltage Suppressors (TVS)

P6SMB Series 6.8 To 600 V 600W

Ratings and Characteristic Curves ($T_A=25^\circ\text{C}$ unless otherwise noted)

Figure 1 - Peak Pulse Power Rating Curve

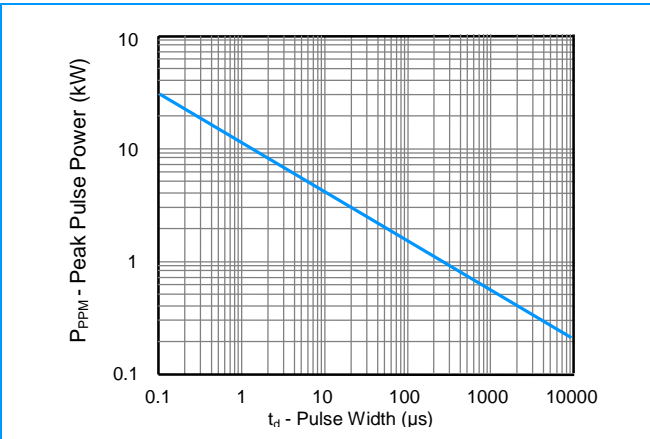

Figure 2 - Pulse Derating Curve

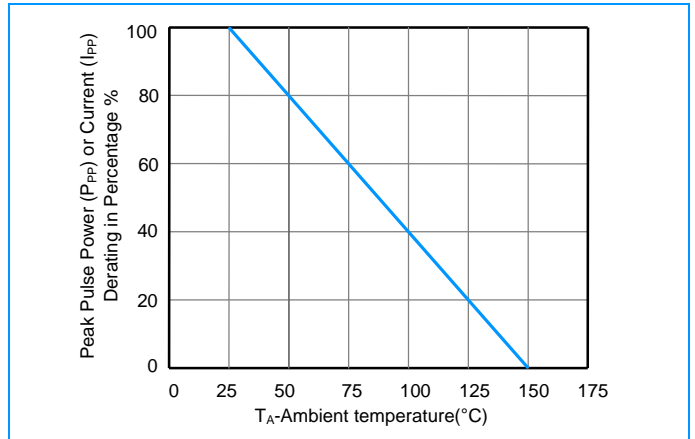

Figure 3 - Pulse Waveform

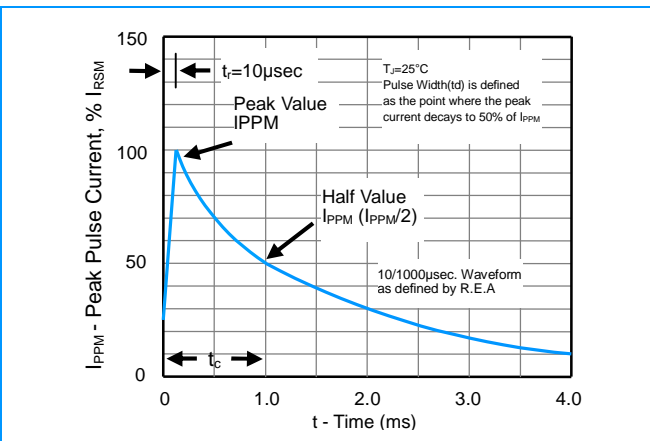

Figure 4 - Typical Junction Capacitance

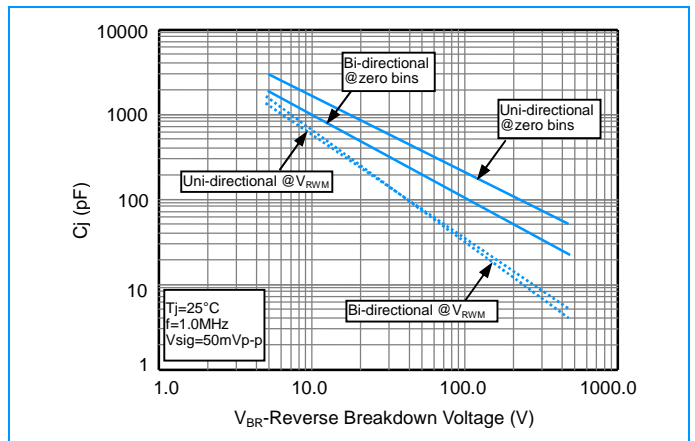

Figure 5 - Steady State Power Derating Curve

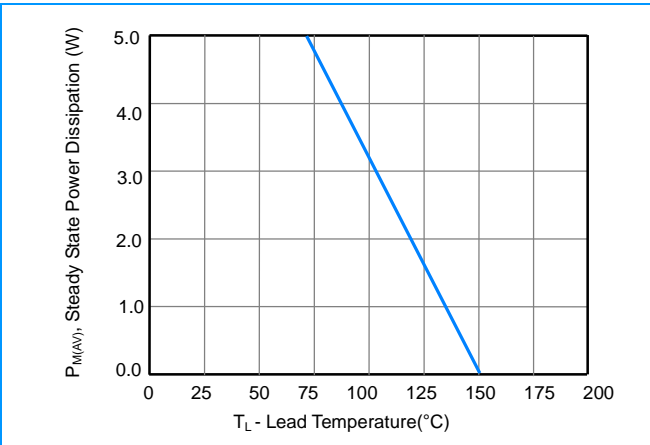
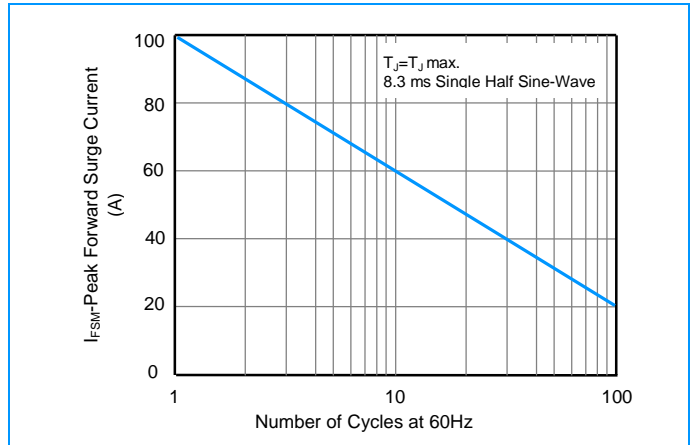

Figure 6 - Maximum Non-Repetitive Surge Current



Surface Mount Transient Voltage Suppressors (TVS)

P6SMB Series 6.8 To 600 V 600W

I-V Curve Characteristics

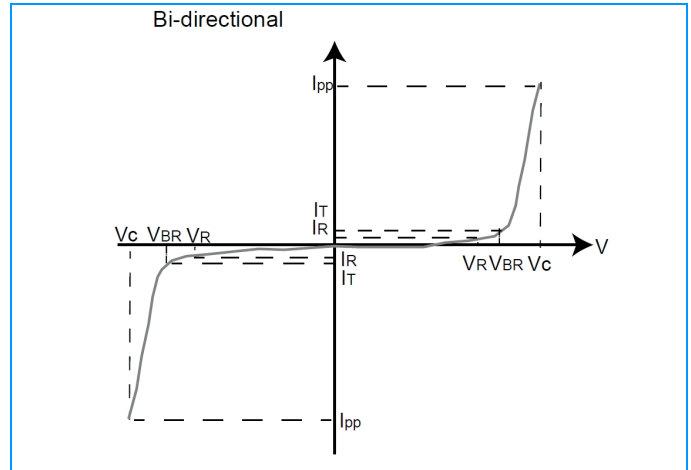
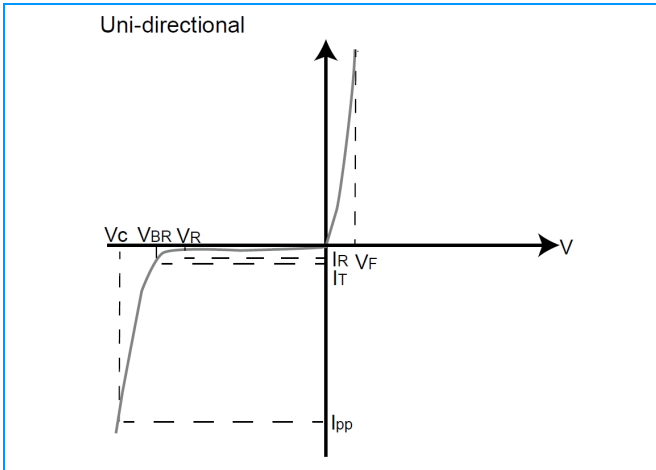

Physical Specifications

Weight	0.003 ounce, 0.093 gram
Case	JEDEC DO-214AA Molded Plastic over glass passivated junction
Polarity	Color band denotes cathode except Bipolar
Terminal	Matte Tin-plated leads, Solderable per JESD22-B102D

Environmental Specifications

Temperature Cycle	JESD22-A104
Pressure Cooker	JESD22-A102
High Temp. Storage	JESD22-A103
HTRB	JESD22-A108
Thermal Shock	JESD22-A106

Soldering Parameters

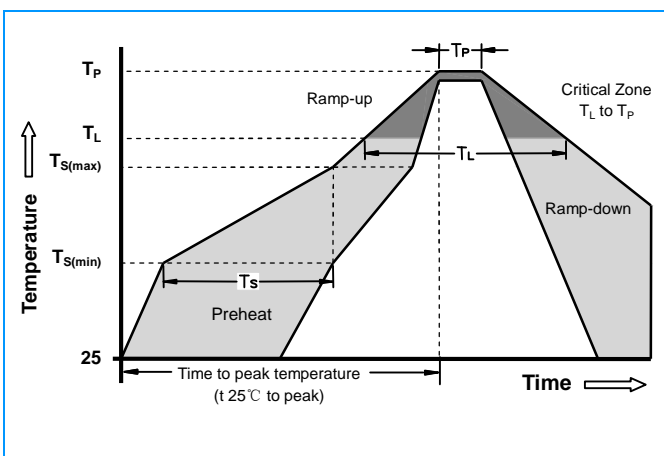

Reflow Condition		Lead-free assembly
Pre Heat	- Temperature Min ($T_{S(min)}$)	150°C
	- Temperature Max ($T_{S(max)}$)	200°C
	- Time (min to max) (t_s)	60 - 180 Seconds
Average ramp up rate (Liquidus Temp T_L) to peak		3°C/second max
$T_{S(max)}$ to T_L - Ramp-up Rate		3°C/second max
Reflow	- Temperature (T_L) (Liquidus)	217°C
	- Time (min to max) (t_s)	60 - 150 Seconds
Peak Temperature (T_P)		260 +0/-5°C
Time within 5°C of actual peak Temperature (t_p)		20 - 40 Seconds
Ramp-down Rate		6°C/second max
Time 25°C to peak Temperature (T_P)		8 minutes Max
Do not exceed		280°C

Surface Mount Transient Voltage Suppressors (TVS)

P6SMB Series 6.8 To 600 V 600W

Dimensions

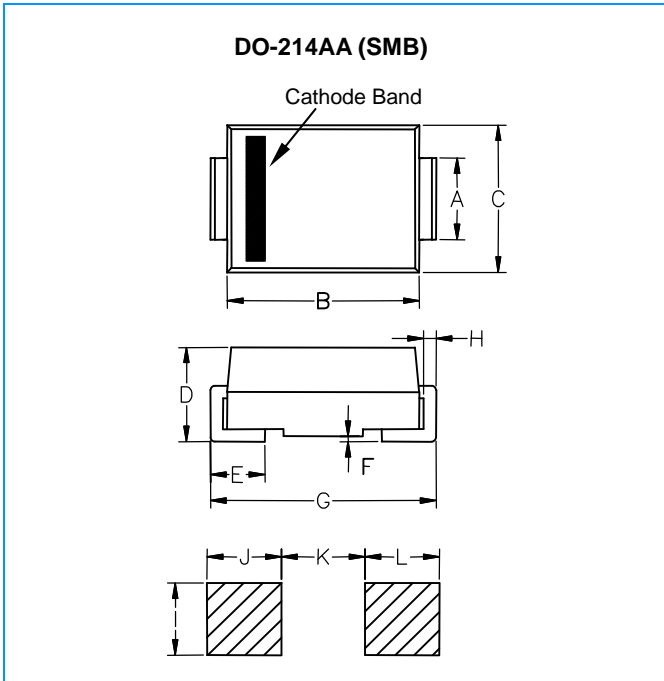

Dimensions	Inches		Millimeters	
	Min	Max	Min	Max
A	0.077	0.087	1.960	2.200
B	0.171	0.191	4.350	4.850
C	0.130	0.155	3.300	3.940
D	0.084	0.096	2.130	2.440
E	0.030	0.060	0.750	1.520
F	-	0.008	-	0.203
G	0.201	0.216	5.100	5.500
H	0.006	0.012	0.152	0.305
I	0.089	-	2.260	-
J	0.085	-	2.160	-
K	-	0.107	-	2.740
L	0.085	-	2.160	-

Part Numbering

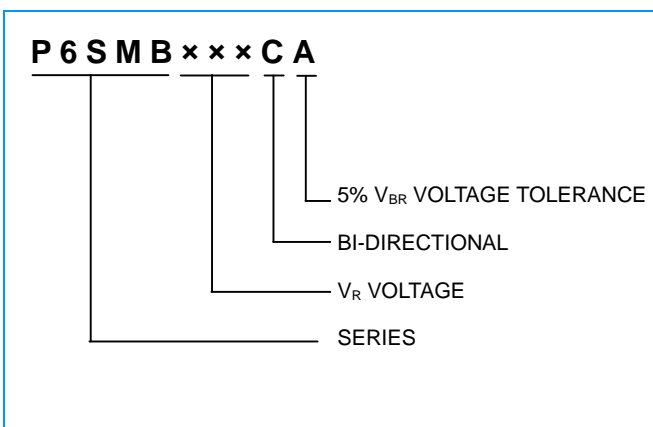

Surface Mount Transient Voltage Suppressors (TVS)

P6SMB Series 6.8 To 600 V 600W

Packaging

Part Number	Component Package	Quantity	Packaging Option	Packaging Specification
P6SMBXXXXX	DO-214AA	500	Tape & Reel -12mm/7"tape	EIA STD RS-481

Tape and Reel Specifications

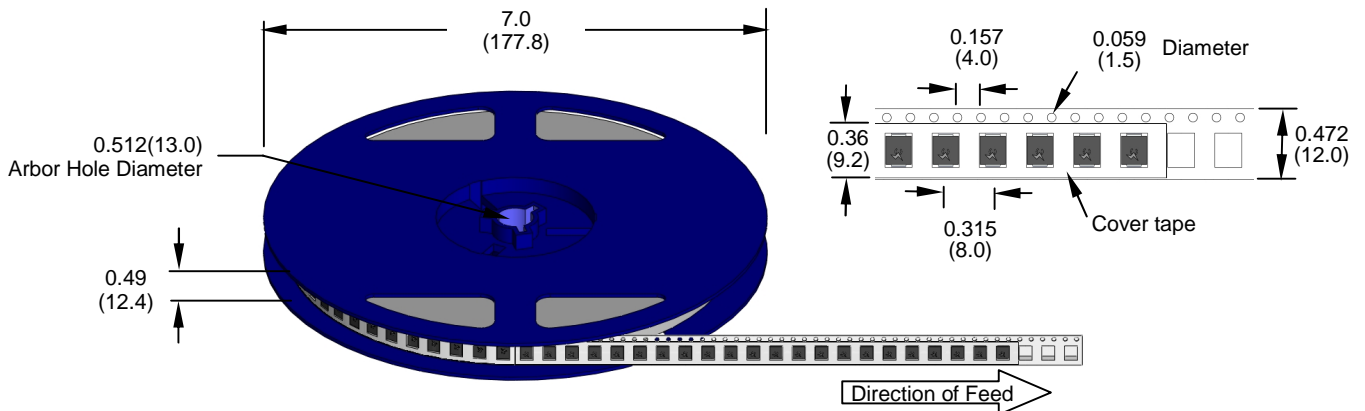

Dimensions are in inches
(and millimeters)