

## Thyristor Surge Suppressors (TSS)

**P0080EC - P5000EC Series - TO-92 @10/700 $\mu$ S, 6KV**

### Description

P0080EC - P5000EC Series are designed to protect broadband equipment such as modems, line card, CPE and DSL from damaging over-voltage transients.

The series provides a surface mount solution that enables equipment to comply with global regulatory standards.

### Features and Benefits

- u Low voltage overshoot
- u Low on-state voltage
- u Does not degrade surge capability after multiple surge events within limit
- u Fails short circuit when surged in excess of ratings
- u Low Capacitance

### Applicable Global Standards

- u TIA-968-A / TIA-968-B
- u ITU K.20/21 Enhanced level
- u ITU K.20/21 Basic Level
- u GR 1089 Inter building
- u GR 1089 Inter building
- u IEC 6100-4-5
- u YD/T 1082
- u YD/T 993
- u YD/T 950

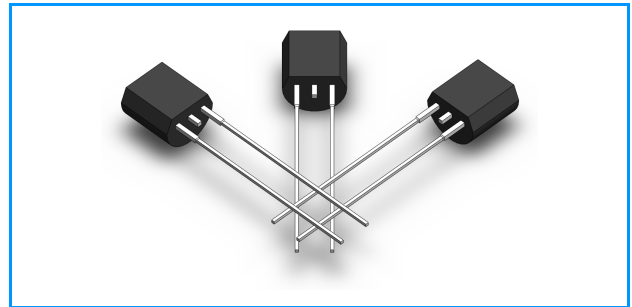

### Pinout Designation

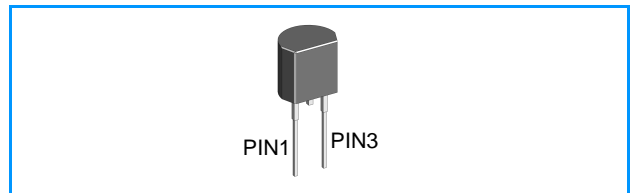

### Schematic Symbol

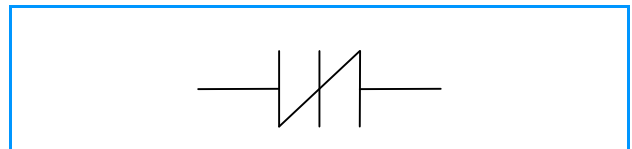

### Electrical Parameters

Parameter	Definition
$I_S$	<b>Switching Current</b> - maximum current required to switch to on state
$I_{DRM}$	<b>Leakage Current</b> - maximum peak off-state current measured at $V_{DRM}$
$I_H$	<b>Holding Current</b> - minimum current required to maintain on state
$I_T$	<b>On-state Current</b> - maximum rated continuous on-state current
$V_S$	<b>Switching Voltage</b> - maximum voltage prior to switching to on state
$V_{DRM}$	<b>Peak Off-state Voltage</b> - maximum voltage that can be applied while maintaining off state
$V_T$	<b>On-state Voltage</b> - maximum voltage measured at rated on-state current
$C_0$	<b>Off-state Capacitance</b> - typical capacitance measured in off state

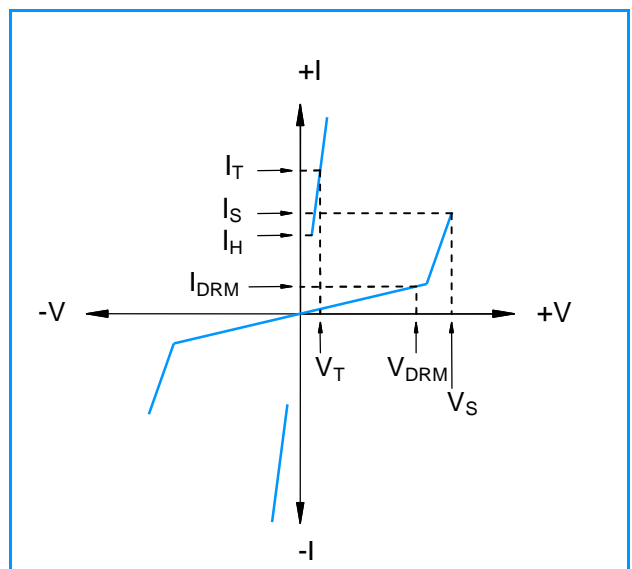

## Thyristor Surge Suppressors (TSS)

**P0080EC - P5000EC Series - TO-92 @10/700μS, 6KV**

### Electrical Characteristics

Part Number	Marking	$V_{DRM}$ @ $I_{DRM}=5\mu A$	$V_S$ @100V/μS	$V_T$ @ $I_T=2.2A$	$I_S$	$I_T$	$I_H$	$C_0$ @1MHz	
		V min	V max	V max	mA max	A max	mA min	pF min	pF max
P0080EC	P0080EC	6	25	4	800	2.2	50	25	150
P0300EC	P0300EC	25	40	4	800	2.2	50	15	140
P0640EC	P0640EC	58	77	4	800	2.2	150	40	60
P0720EC	P0720EC	65	88	4	800	2.2	150	35	60
P0900EC	P0900EC	75	98	4	800	2.2	150	25	55
P1100EC	P1100EC	90	130	4	800	2.2	150	30	50
P1300EC	P1300EC	120	160	4	800	2.2	150	25	45
P1500EC	P1500EC	140	180	4	800	2.2	150	25	40
P1800EC	P1800EC	170	220	4	800	2.2	150	25	35
P2000EC	P2000EC	180	220	4	800	2.2	150	20	35
P2300EC	P2300EC	190	260	4	800	2.2	150	25	35
P2600EC	P2600EC	220	300	4	800	2.2	150	20	35
P3100EC	P3100EC	275	350	4	800	2.2	150	20	35
P3500EC	P3500EC	320	400	4	800	2.2	150	20	35
P4000EC	P4000EC	360	460	4	800	2.2	150	20	35
P4500EC	P4500EC	400	540	4	800	2.2	150	20	35
P5000EC	P5000EC	440	600	4	800	2.2	150	20	35

**Notes:**

- Absolute maximum ratings measured at  $T_A=25^\circ C$  (unless otherwise noted).
- Devices are bi-directional.

### Surge Ratings

Series	$2/10\mu S^1$	$8/20\mu S^1$	$10/160\mu S^1$	$10/560\mu S^1$	$10/1000\mu S^1$	$5/310\mu S^1$	$I_{TSM}$ 50/60 Hz	di/dt
	$2/10\mu S^2$	$1.2/50\mu S^2$	$10/160\mu S^2$	$10/560\mu S^2$	$10/1000\mu S^2$	$10/700\mu S^2$		
	A min	A min	A min	A min	A min	A min	A min	Amps/μs max
C	500	400	200	150	100	150	50	500

**Notes:**

- Current waveform in μs
  - Voltage waveform in μs
- Peak pulse current rating ( $I_{PP}$ ) is repetitive and guaranteed for the life of the product.
  - $I_{PP}$  ratings applicable over temperature range of  $-40^\circ C$  to  $+85^\circ C$
  - The device must initially be in thermal equilibrium with  $-40^\circ C < T_J < +150^\circ C$

### Thermal Considerations

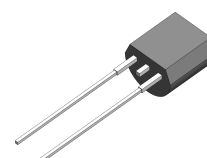
Package	Symbol	Parameter	Value	Unit
TO-92 	$T_J$	Operating Junction Temperature Range	- 40 to + 150	$^\circ C$
	$T_S$	Storage Temperature Range	- 40 to +150	$^\circ C$
	$R_{\theta JA}$	Thermal Resistance: Junction to Ambient	90	$^\circ C/W$

**Thyristor Surge Suppressors (TSS)**

**P0080EC - P5000EC Series - TO-92 @10/700µS, 6KV**

**Characteristic Curves**

**Figure 1 - V-I Characteristics**

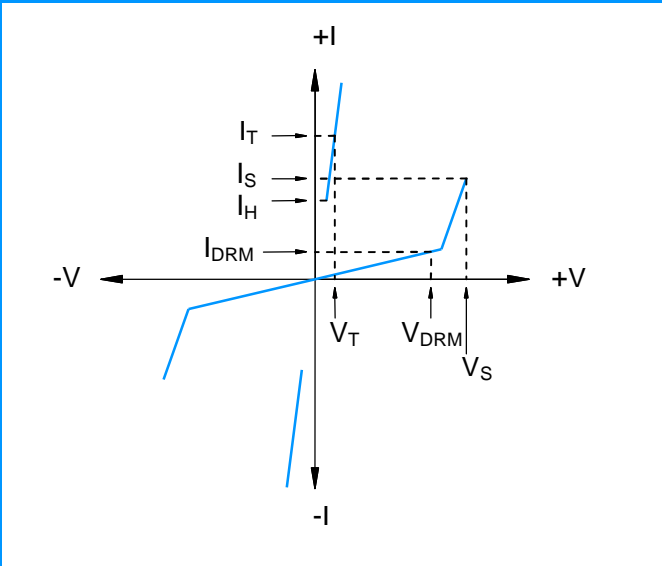

**Figure 2 -  $t_r \times t_d$  Pulse Waveform**

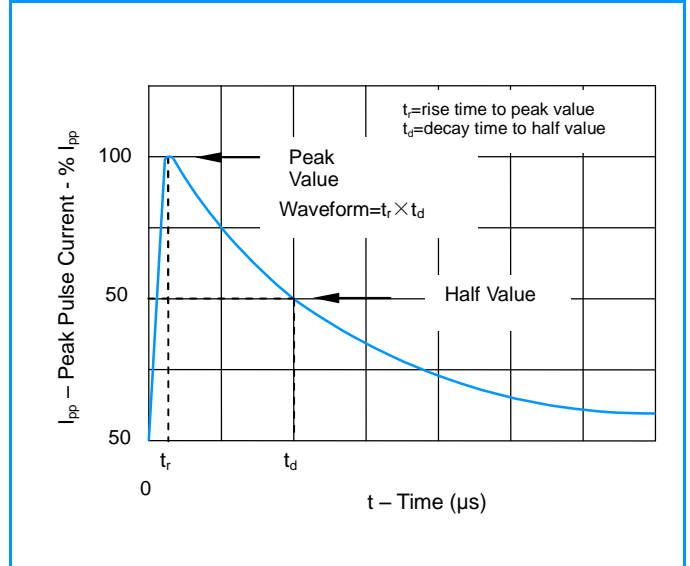

**Figure 3 - Normalized  $V_s$  Change Versus Junction Temperature**

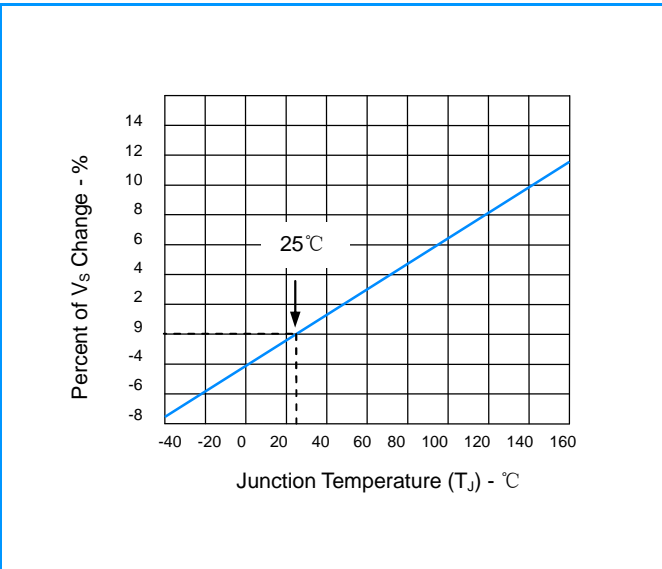

**Figure 4 - Normalized DC Holding Current Versus Case Temperature**

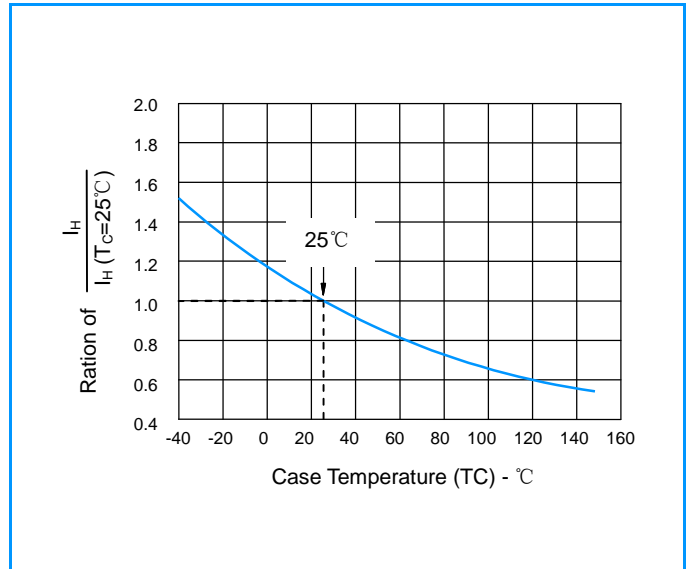

## Thyristor Surge Suppressors (TSS)

**P0080EC - P5000EC Series - TO-92 @10/700 $\mu$ S, 6KV**

### Environmental Specifications

<b>High Temp Voltage Blocking</b>	80% Rated VDRM (VAC Peak) +125°C or +150°C, Lead Material Copper Alloy High Temp Voltage Blocking 504 or 1008 hrs. MIL-STD-750 (Method 1040) JEDEC, JESD22-A-101
<b>Temp Cycling</b>	-65°C to +150°C, 15 min. dwell, 10 up to 100 cycles. MIL-STD-750 (Method 1051) EIA/JEDEC, JESD22-A104
<b>Biased Temp &amp; Humidity</b>	52 VDC (+85°C) 85%RH, 504 up to 1008 hrs. EIA/JEDEC, JESD22-A-101
<b>High Temp Storage</b>	+150°C 1008 hrs. MIL-STD-750 (Method 1031) JEDEC, JESD22-A-101
<b>Low Temp Storage</b>	-65°C, 1008 hrs.
<b>Thermal Shock</b>	0°C to +100°C, 5 min. dwell, 10 sec. transfer, Thermal Shock 10 cycles. MIL-STD-750 (Method 1056) JEDEC, JESD22-A-106
<b>Autoclave (Pressure Cooker Test)</b>	+121°C, 100%RH, 2atm, 24 up to 168 hrs. EIA/Cooker Test) JEDEC, JESD22-A-102
<b>Resistance to Solder Heat</b>	+260°C, 30 secs. MIL-STD-750 (Method 2031)
<b>Moisture Sensitivity Level</b>	85%RH, +85°C, 168 hrs., 3 reflow cycles Level (+260°C Peak). JEDEC-J-STD-020, Level 1

### Physical Specifications

<b>Lead Material</b>	Copper Alloy
<b>Terminal Finish</b>	100% Matte-Tin Plated
<b>Body Material</b>	UL recognized epoxy meeting flammability classification 94V-0

### Soldering Parameters

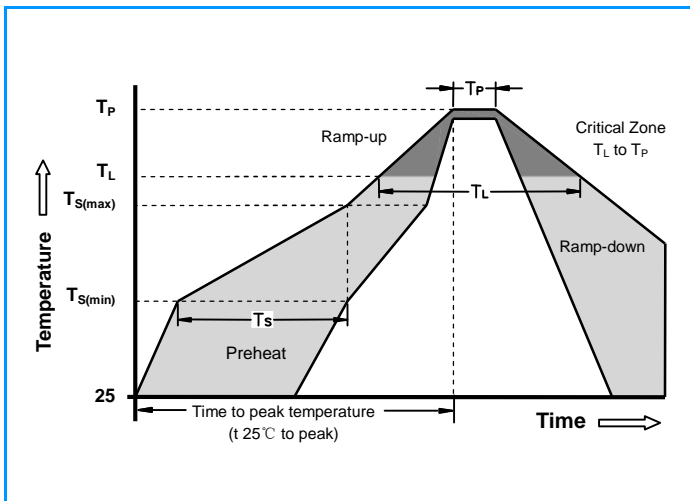

<b>Reflow Condition</b>		Lead-free assembly
<b>Pre Heat</b>	-Temperature Min ( $T_{s(\text{min})}$ )	+150°C
	-Temperature Max ( $T_{s(\text{max})}$ )	+200°C
	-Time (min to max) ( $t_s$ )	60 -180 Seconds
<b>Average ramp up rate ( Liquidus Temp <math>T_L</math> to peak)</b>		3°C/Second Max
<b><math>T_{S(\text{max})}</math> to <math>T_L</math> - Ramp-up Rate</b>		3°C/Second Max
<b>Reflow</b>	- Temperature ( $T_L$ ) (Liquidus)	+217°C
	- Time (min to max) ( $t_s$ )	60 -150 Seconds
<b>Peak Temperature (<math>T_P</math>)</b>		260 +0/-5°C
<b>Time within 5°C of actual peak Temperature (<math>t_p</math>)</b>		30 Seconds Max
<b>Ramp-down Rate</b>		6°C/Second Max
<b>Time 25°C to peak Temperature (<math>T_P</math>)</b>		8 minutes Max
<b>Do not exceed</b>		+260°C

# Thyristor Surge Suppressors (TSS)

**P0080EC - P5000EC Series - TO-92 @10/700 $\mu$ S, 6KV**

## Part Numbering

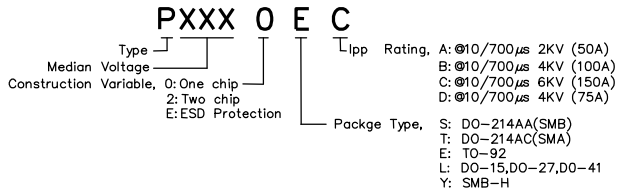

## Part Marking

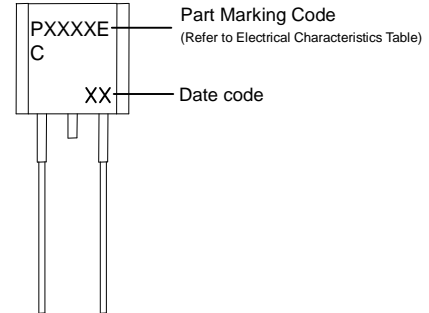

## Dimensions TO-92

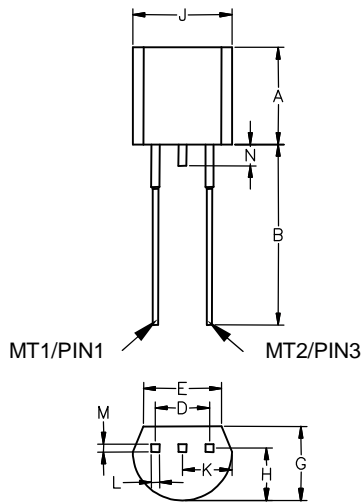

The TO-92 is designed to meet mechanical standards as set forth in JEDEC publication number 95.

Dimensions	Inches		Millimeters	
	Min	Max	Min	Max
A	0.176	0.196	4.47	4.98
B	0.500		12.70	
D	0.095	0.105	2.41	2.67
E	0.150		3.81	
G	0.135	0.145	3.43	3.68
H	0.088	0.096	2.23	2.44
J	0.176	0.186	4.47	4.73
K	0.088	0.096	2.23	2.44
L	0.013	0.019	0.33	0.48
M	0.013	0.017	0.33	0.43
N		0.060		1.52

All leads are insulated from case. Case is electrically non-conductive. (Rated at 1600 V<sub>(AC)</sub> RMS for one minute from leads to case over the operating temperature range.)

Mold flash shall not exceed 0.13 mm per side.

## Packaging

Part Number	Description	Quantity
<b>Pxxx0EC</b>	TO-92 Bulk Pack	1000